

Glidewell HT™ IMPLANT SYSTEM

Restorative Manual



2X R

NOTE 4
glidewell-ht.com

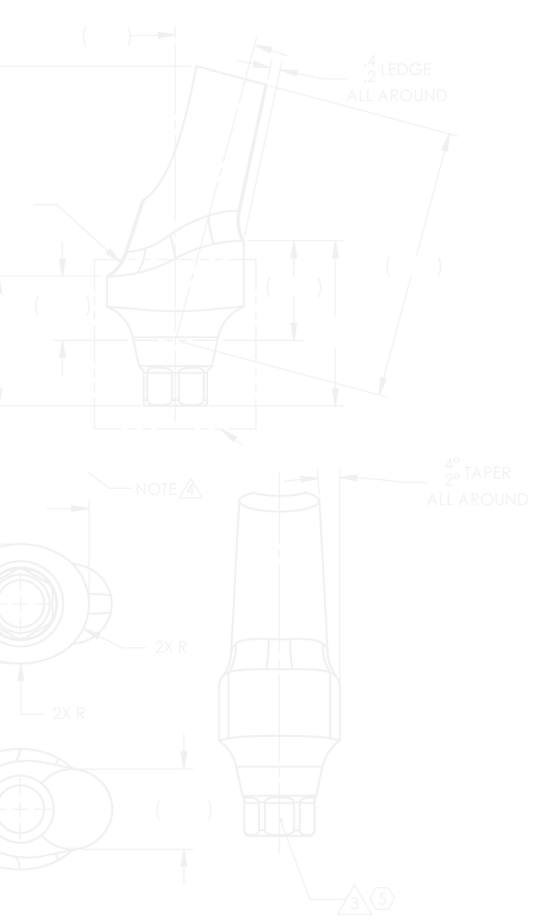

The Glidewell HT™ Implant System

The Glidewell HT™ Implant System, formerly known as the Hahn™ Tapered Implant System, is a premium implant solution that simplifies surgery and provides you with unrivaled support from the most experienced dental lab in the U.S. With a 99.2% success rate backed by an implant-to-crown lifetime warranty, the Glidewell HT Implant promotes success in implant dentistry while lowering your surgical and restorative costs.

- **Simple and efficient** — Easy to use, with a streamlined surgical protocol and length-specific drills
- **Cut your costs** — Priced at a fraction of comparable implant systems — and saves you 20% on your lab bill when you restore your implant case with Glidewell*
- **Clinically proven** — 99.2% success rate and 0.2 mm mean bone loss¹
- **High primary stability** — Deep, sharp threads maximize initial stability and engage bone where directed

“The **Glidewell HT Implant System** is engineered to help dentists provide implant treatment for more patients through **ease of use, reduced costs** and our **unwavering commitment to support your practice** — from implant placement to final restoration.”

Jim Glidewell, CDT

Founder and President of Glidewell



About the Manufacturer

Prismatik Dentalcraft was established in 2006 and includes a carefully assembled team of experts with a proven track record in the design, engineering, and manufacture of dental implants. Bolstered by a support staff of highly respected researchers, material scientists, clinical specialists, and dental technicians, Prismatik is dedicated to advancing implant therapies by combining proven treatment protocols with progressive materials, technologies, and techniques.



Vertical Integration

Our ownership of the entire manufacturing process behind our implant products ensures quality and helps reduce costs for our customers.

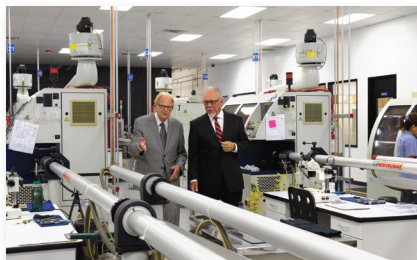

State-of-the-Art Equipment

Our Swiss-type lathes and CNC milling machines are ideal for implants and prosthetics requiring extreme precision.



Made in the USA

Our ISO-certified facility in Irvine, CA, operates under FDA Current Good Manufacturing Practices (CGMPs).

*Discount offered only at Glidewell and cannot be combined with any other special offers. Case must include an implant-level or multi-unit abutment-level impression with a Glidewell HT transfer coping or a digital scan with a Glidewell HT scan body. Impressions over cementable abutments are not eligible for discount.

1. Kerr M, Allen B, Park N. Clinical and radiographic evaluation of tapered implants with an aggressive reverse buttress thread and crestal microthreads: a retrospective study. For the full report, visit glidewell.com/ht-2-year.

Contents

6 RESTORATIVE CONSIDERATIONS

Scope
Intended Use
Contraindications
Warning
Precautions

7

MRI
Sterility
Storage and Handling

8

Prosthetic Component Types
Compatibility
Prosthetic Kit
Torque Values

10 HEALING ABUTMENT

Product Description
Intended Use
Contraindications
Healing Abutment Placement Procedure

11 TEMPORARY ABUTMENT

Product Description
Intended Use
Contraindications
Temporary Abutment Placement Procedure

13 IMPRESSION COPING

Product Description
Intended Use
Contraindications

14 Closed-Tray Impression Procedure

15 Open-Tray Impression Procedure

16 TITANIUM SCAN BODY

Product Description
Intended Use
Contraindications

17 Digital Impression Procedure

18 IMPLANT ANALOG

Product Description
Intended Use
Contraindications
Implant Analog Procedure

19 TITANIUM ABUTMENT

Product Description
Intended Use
Contraindications
Restorative Procedure with Titanium Abutments

21 ESTHETIC ABUTMENT

Product Description
Intended Use
Contraindications
Restorative Procedure with Esthetic Abutments

24 UCLA ABUTMENT

Product Description
Intended Use
Contraindications
Casting Custom Abutments with Gold UCLAs
Creating a Diagnostic Wax-up with Plastic UCLAs

Contents

27 TITANIUM SCREW / GUIDE PIN

- Product Description
- Intended Use
- Contraindications
- Attachment Procedure
- Retrieval Procedure

29 MULTI-UNIT ABUTMENT

- Product Description
- Intended Use
- Contraindications

30 Implant Orientation

Restorative Procedure with Multi-Unit Abutments

36 LOCATOR® ABUTMENT

- Intended Use
- Contraindications
- Caution
- Single-Use Devices
- Sterilization
- LOCATOR Abutment Features

37 Restorative Procedure with LOCATOR Abutments

42 PRODUCT PACKAGING

43 POLICIES AND WARRANTY



Glidewell HT™ Implant is a trademark of Prismatic Dentalcraft, Inc.

Copyright © 2024, Prismatic Dentalcraft, Inc. Prismatic Dentalcraft, Inc. is not responsible for any damages or other liabilities (including attorney fees) resulting, or claimed to result in whole or in part, from actual or alleged problems arising out of the use of this information. The techniques, procedures and theories presented herein are provided in good faith and believed to be correct as of the date hereof. Any dental professional viewing this presentation must make his or her own decisions about the use of the materials and techniques for specific situations.

No representations as to the completeness or accuracy of this information is given, and no representations or warranties, either expressed or implied, of merchantability, fitness for a particular purpose or of any other nature are made here under with respect to the information or the product to which information refers.

Inclusive® is a registered trademark of Prismatic Dentalcraft, Inc. All third-party trademarks are property of their respective owners.

Restorative Considerations

Scope

This manual outlines the appropriate general procedures for using Glidewell HT™ Implant Prosthetic Components in the process of restoring endosseous Glidewell HT Implants with a common range of prosthetic solutions, such as single- or multiple-unit crowns and bridges (cementable or screw-retained), fixed-removable full-arch prostheses, or attachments for securing removable implant overdentures.

The procedures and guidelines presented herein are not adequate to allow inexperienced clinicians to administer professional implant restorative dentistry, and are not intended to be a substitute for formal clinical or laboratory training. Glidewell HT Implant Prosthetic Components and accessories should only be used by individuals with training and experience specific to their clinically accepted application. Prismahtik Dentalcraft, Inc. is not liable for damages resulting from treatment outside of its control. Responsibility rests with the provider.

CAUTION: U.S. federal law restricts this device to sale by, or on the order of, a licensed dentist or physician.

Intended Use

Glidewell HT Implant Prosthetic Components are indicated for use in partially or fully edentulous patients to retain or support maxillary and mandibular single-unit, multiple-unit, and overdenture dental restorations in provisional or long-term applications. For product-specific usage, please refer to the individual product information sections contained within this manual.

Contraindications

Glidewell HT Implant Prosthetic Components contain no side effects, according to current knowledge. Do not use Glidewell HT Implant Prosthetic Components in patients with hypersensitivity to any material listed in the product description. For product-specific contraindications, please refer to the individual product information sections contained within this restorative manual.

Warning

Do not reuse Glidewell HT Implant Prosthetic Components labeled for single use, as they are intended to be used on an individual patient only. The reuse of such device may result in product contamination, patient infection, or failure of the device to perform as intended.

Precautions

Glidewell HT Implant Prosthetic Components may only be used for their intended purpose, in accordance with general rules for restorative dental treatment, occupational safety, and accident prevention. Improper technique associated with the use of these devices may result in adverse effects including but not limited to: implant fracture or failure, loss of supporting bone, restoration fracture or failure, and compromised oral function. It is the responsibility of the licensed clinician or laboratory technician to determine the appropriate treatment protocols and device selection. Glidewell HT Implant devices should only be used for dental procedures with Glidewell HT Implants. Prior to restorative treatment, ensure that the required components, instruments, and ancillary materials are complete, functional, and available in the correct quantities. If the indications and intended usage are not clearly specified, treatment should be suspended until these considerations have been clarified. Inspect all components prior to use. Do not use any component that is damaged or unclean. Components and accessories used intraorally should be secured to prevent aspiration or ingestion.

Following successful implant placement, verify primary stability before proceeding with the delivery of a permanent or provisional prosthesis. The healing period varies depending on the quality of the bone at the implantation site, the tissue response to the implanted fixture, and the surgeon's evaluation of the patient's bone density at the time of the surgical procedure. Distribution of stress is an important consideration. Particular care should be taken to avoid the application of force on the dental implant during the healing period. Post-healing, care should

Restorative Considerations

still be taken to avoid excessive loads significantly transverse to the implant axes. In addition, proper occlusion should be evaluated on the provisional or definitive implant restoration to avoid excessive force during everyday function.

Due to the high thermal conductivity of titanium, prefabricated titanium abutments should not be modified in the oral cavity. Any necessary modifications should be made extraorally by attaching the abutment to an implant analog retained by an analog holder or captured in a working model. Modify with a fine-diamond or carbide bur.

MRI

Glidewell HT Implant Prosthetic Components have not been evaluated for safety and compatibility in the magnetic resonance (MR) environment. They have not been tested for heating, migration, or image artifact in the MR environment. The safety of Glidewell HT Implant Prosthetic Components in the MR environment is therefore unknown. Magnetic resonance imaging (MRI) scans of a patient who bears one or more of these devices may result in patient injury.

Sterility

Refer to individual product labels for sterility classification. Products labeled STERILE are intended for single-use only, prior to the expiration date printed on the product label. Do not use sterile products if the packaging has been compromised or previously opened. Do not re-sterilize or autoclave except where instructions to do so are provided for that product by the manufacturer.

Glidewell HT Implant Prosthetic Components labeled NON-STERILE should be cleaned, disinfected, and sterilized according to a validated method prior to use in the oral environment.

- **Cleaning:** Prepare cleaning solution using 5 mL of dish soap per gallon of tap water. Fully immerse the devices in solution and scrub them with a soft-bristle brush. Remove the components and rinse them under running tap water. Dry the devices with a clean, lint-free cloth.

The recommended sterilization process is based on the ANSI/AAMI/ISO 17665-1 and ANSI/AAMI ST79 guidelines, as follows:

- **Sterilization:** Gravity-fed sterilizers: Autoclave in sterilization pouch for 30 minutes at 121°C (250°F). Devices are to be used immediately after sterilization.

⚠ NOTE: The validated procedures require the use of FDA-cleared sterilization trays, wraps, biological indicators, chemical indicators, and other sterilization accessories labeled for the sterilization cycle recommended. The healthcare facility should monitor the sterilizer for the facility according to an FDA-recognized sterility assurance standard such as ANSI/AAMI ST79.

Storage and Handling

Glidewell HT Prosthetic Components labeled STERILE should be stored in a dry location at room temperature, in their original packaging. Users are advised to visually inspect packaging to ensure seals and contents are intact prior to use. Please refer to the individual product label for all relevant product information and cautions. Sterile products are intended for single-use only, prior to the expiration date. Do not use sterile products if the packaging has been compromised or previously opened. Do not resterilize.

Products labeled NON-STERILE should be cleaned and sterilized according to a validated method prior to use in the oral environment.

Restorative Considerations

Prosthetic Component Types

The Glidewell HT Implant System features an extensive line of prosthetic components:

- Healing Abutments
- Temporary Abutments
- Transfer Copings
- Titanium Scan Bodies
- Analogs
- Titanium Abutments
- Titanium Esthetic Abutments
- UCLA Abutments
- Multi-Unit Abutments
- Titanium Screws and Guide Pins

The Glidewell HT line of prosthetic components also features LOCATOR Abutments, LOCATOR Attachments, and related LOCATOR tools and accessories manufactured by Zest Anchors (Escondido, Calif.).

Prosthetic Compatibility

Prosthetic components for the Glidewell HT Implant System are compatible with Glidewell HT Implants. The platform-specific compatibility of each component is indicated on the individual product label. The availability of a particular type of prosthetic component may be limited by restorative platform, geographical territory, or other considerations. For a complete product listing, please refer to the **Glidewell HT Implant System Product Catalog**, or contact a sales representative.

Glidewell HT™ Implant Prosthetic Kit

The Glidewell HT™ Implant Prosthetic Kit contains all of the instruments required to properly place Glidewell HT Implant Prosthetic Components. The Glidewell HT Implant Prosthetic Drivers (long and short) feature a popular connection widely used in the implant marketplace. Before initiating any clinical procedure utilizing Glidewell HT Implant Prosthetic Components, please ensure that a compatible driver is on hand.

Torque Values

Glidewell HT Implant Prosthetic Components designed to support a provisional or final prosthesis should be affixed to the implant and tightened using a properly metered torque wrench to the value recommended by the implant manufacturer, as indicated in the table below. The application of torque in excess of the manufacturer's recommended value may result in fracture of the implant fixture or retaining screw. Insufficient application of torque may result in screw loosening or inadequate component attachment.

Manufacturer's Recommended Torque (Ncm)

Glidewell HT Implant Diameter	Healing/ Temporary Abutment	Titanium Abutment/ Screw	Multi-Unit Abutment/ Screw	Multi-Unit Prosthetic Screw
3.0 mm	15 Ncm	15 Ncm	—	—
3.5 mm/4.3 mm/5.0 mm/7.0 mm	15 Ncm	35 Ncm	35 Ncm	15 Ncm

(—) indicates product not available. Any screw-retained prosthetic component not listed in the table above should be hand-tightened only.

Restorative Considerations

RESTORATIVE CONSIDERATIONS

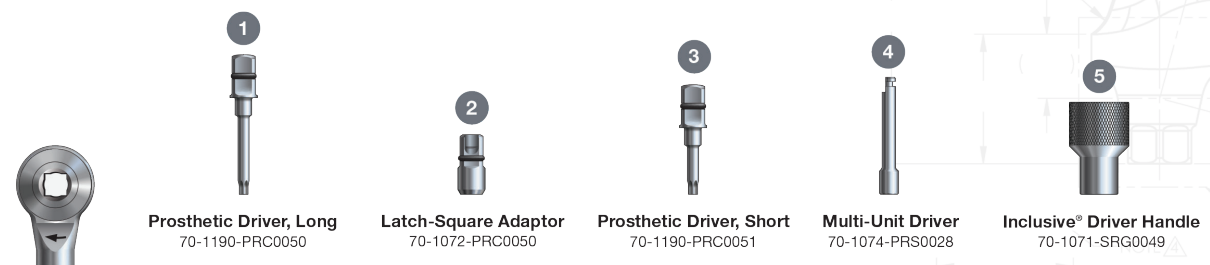

1
Prosthetic Driver, Long
70-1190-PRC0050

2
Latch-Square Adaptor
70-1072-PRC0050

3
Prosthetic Driver, Short
70-1190-PRC0051

4
Multi-Unit Driver
70-1074-PRS0028

5
Inclusive® Driver Handle
70-1071-SRG0049



6
Adjustable Torque Wrench
70-1071-SRG0155

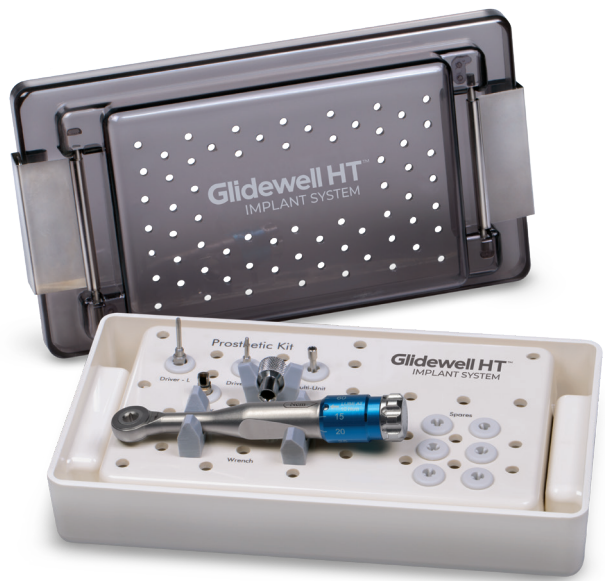
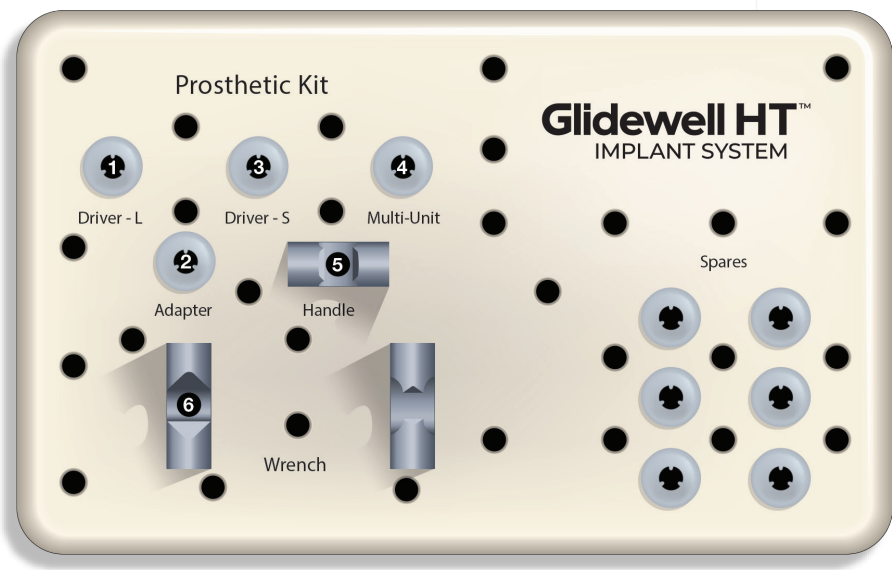

Glidewell HT™ Implant Healing Abutment

Product Description

A Glidewell HT™ Implant Healing Abutment is delivered post-implant placement to close the implant connection and aid in soft-tissue management during the healing phase. Healing abutments may be delivered immediately (single-stage protocol) or after an initial healing period (two-stage protocol), depending upon implant stability. Healing abutments are precisely machined from titanium alloy. The apical portion of the healing abutment is threaded for integration with the internal cavity of a seated implant. The occlusal surface of the healing abutment contains an instrumentation port compatible with the Glidewell HT™ Implant Prosthetic Driver. Each healing abutment is specific to the restorative platform of the seated implant.

Material Composition	Sterility
Titanium alloy (Ti6Al4V)	Sterile

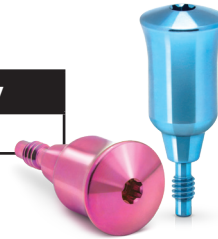

Intended Use

Glidewell HT Implant Healing Abutments are prefabricated prosthetic components directly connected to endosseous dental implants when delayed loading is indicated, intended to close the implant connection during endosseous and gingival healing.

Contraindications

Glidewell HT Implant Healing Abutments are transgingival components. They are not intended for complete gingival submersion.

Healing Abutment Placement Procedure

■ Select a Healing Abutment

- 1) Verify adequate primary stability of the implant before seating any Glidewell HT Implant Healing Abutment.
- 2) Select the appropriate Glidewell HT Implant Healing Abutment based on the implant diameter, soft-tissue depth, and desired emergence profile.

■ Place the Healing Abutment

- 1) Insert the Glidewell HT Implant Healing Abutment into the internal connection cavity of the seated implant, making sure it enters at the same angle as the implant to avoid potential damage that may result from cross-threading.
- 2) Rotate the Glidewell HT Implant Healing Abutment clockwise until engaged with the internal threads of the implant connection cavity.
- 3) Using the appropriate driver, advance threaded delivery of the Glidewell HT Implant Healing Abutment until fully seated against the implant platform.
- 4) Verify complete seating of the Glidewell HT Implant Healing Abutment against the implant platform. Utilize radiography to do so, if clinically appropriate.

■ Close the Flap

If a soft-tissue flap has been reflected to facilitate implant placement, adapt the soft tissue tightly around the seated Glidewell HT Implant Healing Abutment and suture into place.

Glidewell HT™ Implant Temporary Abutment

Product Description

Glidewell HT™ Implant Temporary Abutments are indicated for the fabrication of temporary screw-retained restorations. Provisional restorations can be made chairside using any standard fabrication technique (e.g., vacuum-formed sheet, prefabricated crown/bridge form, etc.). Temporary abutments are precisely machined from titanium alloy and attached to the implant fixture (or implant analog) by a titanium screw or provisional guide pin. Each temporary abutment is specific to the restorative platform of the seated implant.

Engaging temporary abutments are indicated for single-unit restorations to prevent rotation of the provisional crown. *Non-engaging* temporary abutments are indicated for multi-unit bridges, and therefore avoid the unnecessary anti-rotational implant connection feature to allow for a passive path of insertion.

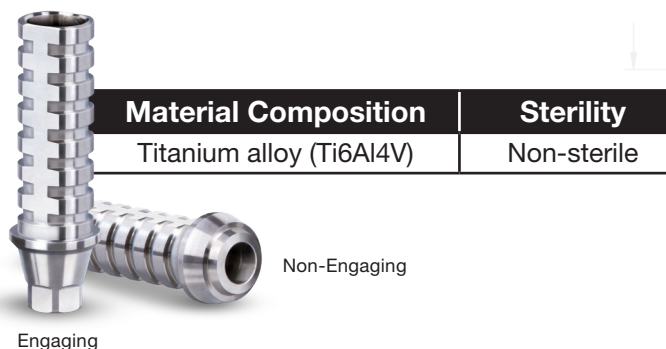

Intended Use

Glidewell HT Implant Temporary Abutments are prefabricated prosthetic components directly connected to endosseous dental implants. They are intended for use to support single- or multiple-unit prostheses in the mandible or maxilla for up to 180 days during endosseous and gingival healing, or for fabrication of try-in prostheses.

Contraindications

Glidewell HT Implant Temporary Abutments are not intended for applications exceeding 180 days during endosseous and gingival healing.

Temporary Abutment Placement Procedure

■ Select a Temporary Abutment

- 1) Verify adequate primary stability of the implant before seating any Glidewell HT Implant Temporary Abutment.
- 2) Select the appropriate Glidewell HT Implant Temporary Abutment based on the implant diameter and type of provisional restoration to be fabricated.

■ Place the Temporary Abutment

- 1) Modify the Glidewell HT Implant Temporary Abutment as needed prior to seating.
- 2) Seat the base of the Glidewell HT Implant Temporary Abutment against the exposed implant platform (or implant analog, if the provisional is being fabricated on a model). If engaging, align the anti-rotational connection feature of the abutment with the internal cavity of the seated implant (or implant analog).

Glidewell HT™ Implant Temporary Abutment

- 3) Using the Glidewell HT Implant Guide Pin packaged with the Glidewell HT Implant Temporary Abutment, hand-tighten the abutment into place against the implant (or implant analog).
- 4) Block out any undercuts on adjacent teeth. Failure to do so may result in the provisional becoming locked in during reline.
- 5) Prepare the provisional crown or bridge form by drilling a hole through the mold directly above the seated implant (or implant analog).

■ Fabricate the Provisional Restoration

- 1) Fill the plastic crown or bridge form with composite resin, acrylic, or other temporary crown-and-bridge material. Care must be taken to confine temporary crown-and-bridge material to the restoration space only.
- 2) Place the plastic mold onto the ridge or model. The guide pin should protrude through the hole previously drilled into the mold. Apply vertical pressure to the mold and confirm that it is firmly seated on all guide teeth.
- 3) While maintaining pressure, follow curing procedures for the chosen crown-and-bridge material.
- 4) Once the crown-and-bridge material is properly cured, remove the screw.
- 5) Remove the mold and provisional restoration from the ridge together. The Glidewell HT Implant Temporary Abutments should be captured within the restoration.
- 6) Remove the restoration from the mold and make adjustments as needed.

■ Place the Provisional Restoration

- 1) Reseat the provisional restoration onto the ridge. Utilize radiography to verify complete seating, if clinically appropriate.
- 2) Locate the Glidewell HT Implant Titanium Screw that came packaged with the Glidewell HT Implant Temporary Abutment.
- 3) Using the appropriate driver, advance threaded delivery of the titanium screw until fully seated, in order to secure the temporary abutment to the implant.
- 4) Using the appropriate torque wrench, tighten the titanium screw to the recommended value for a temporary restoration (see "Torque Values" on page 8).
- 5) Fill the screw access hole with cotton, Teflon tape, gutta-percha, or other suitable material.
- 6) Seal the screw access hole with temporary veneering material.

Glidewell HT™ Implant Impression Coping

Product Description

Glidewell HT™ Implant Impression Copings are used to transmit the position, angulation, and connection feature orientation of seated implants when captured in an elastomeric impression. Impressions may be taken with either the indirect or direct technique, depending on the clinician's preference and chairside conditions. Impression copings are precisely machined from titanium alloy and attached to the implant fixture by a titanium screw. Each impression coping is specific to the restorative platform of the seated implant, as well as the transfer technique and desired emergence profile.

Closed-tray impression copings are for use when employing an indirect transfer technique. *Open-tray* impression copings are for use when using a direct transfer technique. It is important to use the appropriate impression coping for the transfer technique employed. Using a closed-tray impression coping with an open tray will result in an unreliable transfer, as the lack of undercuts on the closed-tray coping do not impress a vertical stop for repositioning the coping without the surface of a closed tray.

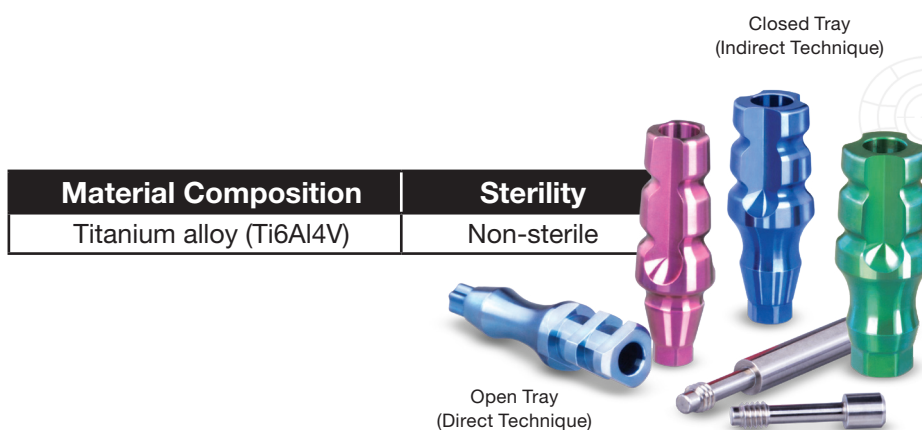

Each Glidewell HT Implant Closed-Tray Impression Coping comes packaged with a closed-tray transfer coping screw. Do not use an open-tray transfer coping screw with a closed-tray impression coping, as the dissimilar screw lengths will allow the coping to slide along the screw shaft in an unpredictable manner.

Each Glidewell HT Implant Open-Tray Impression Coping comes packaged with an open-tray transfer coping screw.

Intended Use

Glidewell HT Implant Impression Copings are prefabricated prosthetic components directly connected to endosseous dental implants for the purpose of capturing implant position in an elastomeric impression of the mandible or maxilla.

Contraindications

Glidewell HT Implant Impression Copings should not be used for digital impressions captured with an intraoral scanner.

Glidewell HT™ Implant Impression Coping

Closed-Tray Impression Procedure

■ Select a Closed-Tray Impression Coping

- 1) Verify adequate primary stability of the implant before seating any Glidewell HT Implant Closed-Tray Impression Coping.
- 2) Select the appropriate Glidewell HT Implant Closed-Tray Impression Coping based on the implant diameter and transfer technique to be used.

■ Place the Closed-Tray Impression Coping

- 1) Ensure gingival tissue is sufficiently withdrawn from the implant access site in order to avoid pinching.
- 2) Seat the Glidewell HT Implant Closed-Tray Impression Coping onto the implant fixture so the anti-rotational features of the connection engage. Hand-tighten into place using the closed-tray transfer coping screw (provided).

⚠ NOTE: It is recommended that a radiograph be taken of the implant-coping connection to confirm the impression coping is completely seated before proceeding.

■ Capture the Impression

- 1) Follow documentation for the chosen impression material to take a full-arch elastomeric impression.
- 2) Once the impression material has set within the closed tray, remove the tray from the patient's ridge. The Glidewell HT Implant Closed-Tray Impression Coping will remain connected to the seated implant.

■ Record Implant Placement

- 1) Unscrew the Glidewell HT Implant Closed-Tray Impression Coping from the seated implant and remove. Mount a corresponding implant analog on the closed-tray impression coping and fasten with the same closed-tray transfer coping screw.
- 2) Reposition the closed-tray impression coping into its corresponding depression in the impression tray and press firmly to engage. The implant analog should protrude from the impression.
- 3) Proceed with the fabrication of a stone model using standard laboratory techniques. Upon separation, the implant analog is a part of the master cast, replicating the position of the implant seated in the oral cavity.

Glidewell HT™ Implant Impression Coping

Open-Tray Impression Procedure

■ Select an Open-Tray Impression Coping

- 1) Verify adequate primary stability of the implant before seating any Glidewell HT Implant Open-Tray Impression Coping.
- 2) Select the appropriate Glidewell HT Implant Open-Tray Impression Coping based on the implant diameter and transfer technique to be used.

■ Place the Open-Tray Impression Coping

- 1) Ensure gingival tissue is sufficiently withdrawn from the implant access site in order to avoid pinching.
- 2) Seat the Glidewell HT Implant Open-Tray Impression Coping onto the implant fixture so the anti-rotational features of the connection engage. Hand-tighten into place using the open-tray transfer coping screw (provided).
- 3) If a blockout is desired, slide a rigid piece of plastic tubing over the open-tray transfer coping screw, making sure it rests firmly on the occlusal end of the open-tray impression coping.

■ Prepare the Impression Tray

Using a custom tray, prepare a hole in the tray that will align with the Glidewell HT Implant Open-Tray Impression Coping and the protruding open-tray transfer coping screw when the impression is taken.

⚠ NOTE: It is recommended that a radiograph be taken of the implant-coping connection site to confirm the transfer coping is completely seated before proceeding.

■ Capture the Impression

- 1) Follow documentation for the chosen impression material to take a full-arch elastomeric impression.
- 2) Once the impression material has set within the open tray, remove the blockout tube (if any) to expose the protruding open-tray transfer coping screw.
- 3) With the tray still in place on the ridge, unscrew and remove the open-tray transfer coping screw from the Glidewell HT Implant Open-Tray Impression Coping.
- 4) Remove the tray from the patient's ridge. The open-tray impression coping should be captured by the impression material.

■ Record Implant Placement

- 1) Mount a corresponding implant analog on the Glidewell HT Implant Open-Tray Impression Coping captured within the impression. Fasten using the open-tray transfer coping screw (provided), making sure to maintain a hold on the analog rather than the impression tray, so as not to rotate the impression coping in the impression material.
- 2) Proceed with the fabrication of a stone model using standard laboratory techniques. Upon separation, the implant analog is a part of the master cast, replicating the position of the implant seated in the oral cavity.

Glidewell HT™ Implant Titanium Scan Body

Product Description

Titanium scan bodies are used to transmit highly accurate position and angulation data of seated implants when scanned with an intraoral or desktop digital scanner. Titanium scan bodies and internal screws are manufactured from titanium alloy conforming to ASTM F136. A titanium scan body is attached to the implant utilizing the internal screw, which is compatible with the specified implant system. Each scan body is specific to the restorative platform of the seated implant. Always use the internal screw to attach the scan body to the implant, tightening the screw to hold the scan body in place. Hand-tighten only, using the appropriate driver. Titanium scan bodies are radiopaque and are designed for both clinical and laboratory use. Titanium scan bodies that are designed for chairside use with intraoral scanners are connected to the original implant fixtures. Their opacity on a radiograph allows accurate confirmation of complete seating. Placed intraorally (attached to an implant in a patient's mouth), titanium scan bodies for clinical use are intended for single use only and retained in the patient for no longer than 1 hour. Titanium scan bodies, when used in a laboratory, are used with implant analogs on a stone model. Used in the laboratory (attached to an implant analog in a working cast), titanium scan bodies can be re-used. Inspect each titanium scan body prior to use. Do not use a titanium scan body that is damaged or unclean. Titanium scan bodies are packaged non-sterile.

Material Composition	Sterility
• Titanium alloy (Ti6Al4V)	Non-sterile



Intended Use

Titanium scan bodies are intended to be used during a digital scanning procedure to capture a seated implant's axis, indexing feature orientation, and position relative to adjacent dentition. They are intended for use as an aid in prosthetic rehabilitation and used as an accessory with endosseous dental implants when tissue contact will last less than 1 hour.

Accessories

Each Glidewell HT Implant Titanium Scan Body is packaged with a scan body screw.

Contraindications

- Multiple use in a clinical setting is contraindicated due to the risk of cross-contamination.
- Titanium scan bodies for clinical use should not be used for elastomeric impressions or bite registrations.

Glidewell HT™ Implant Titanium Scan Body

Sterility

Titanium scan bodies must be cleaned and sterilized prior to clinical use, according to a validated method.

- **Cleaning:** Prepare cleaning solution using 5 mL of dish soap per gallon of tap water. Fully immerse the devices in solution and scrub them with a soft-bristle brush. Remove the components and rinse them under running tap water. Dry the devices with a clean, lint-free cloth.

The recommended sterilization process is based on the ANSI/AAMI/ISO 17665-1 and ANSI/AAMI ST79 guidelines, as follows:

- **Sterilization:** Gravity-fed sterilizers: Autoclave in sterilization pouch for 30 minutes at 121°C (250°F). Devices are to be used immediately after sterilization.

⚠ NOTE: The validated procedures require the use of FDA-cleared sterilization trays, wraps, biological indicators, chemical indicators, and other sterilization accessories labeled for the sterilization cycle recommended. The healthcare facility should monitor the sterilizer for the facility according to an FDA-recognized sterility assurance standard such as ANSI/AAMI ST79.

Digital Impression Procedure

■ Clinical Instructions for Use

- 1) Verify the proper titanium scan body is selected to match the implant system and diameter.
- 2) Secure the titanium scan body to prevent aspiration or swallowing.
- 3) Place the titanium scan body into the implant. Rotate until you feel the titanium scan body engage the indexing element within the implant.
- 4) Hand-tighten the screw using the appropriate driver for the implant system.
- 5) Verify proper seating of the titanium scan body into the implant with an X-ray.
- 6) Scan per your intraoral scanner's instructions.

■ Laboratory Instructions for Use

- 1) Verify the proper titanium scan body is selected to match the implant system and diameter.
- 2) Place the titanium scan body into the implant replica. Rotate until you feel the titanium scan body engage the indexing element within the implant replica.
- 3) Hand-tighten the screw using the appropriate driver for the implant system.
- 4) Scan per your 3D scanner's instructions.

Glidewell HT™ Implant Analog

Product Description

Glidewell HT™ Implant Analogs are platform-specific replicas of dental implant fixtures, used in a working model to represent the location and platform orientation of a seated implant. They are not intended for intraoral use. Prior to the casting process, the appropriate analog is attached to each impression coping captured in an elastomeric impression. Because each analog is specific to the restorative platform of the seated implant, it is critical that the analog platform matches that of the actual fixture in the oral environment.

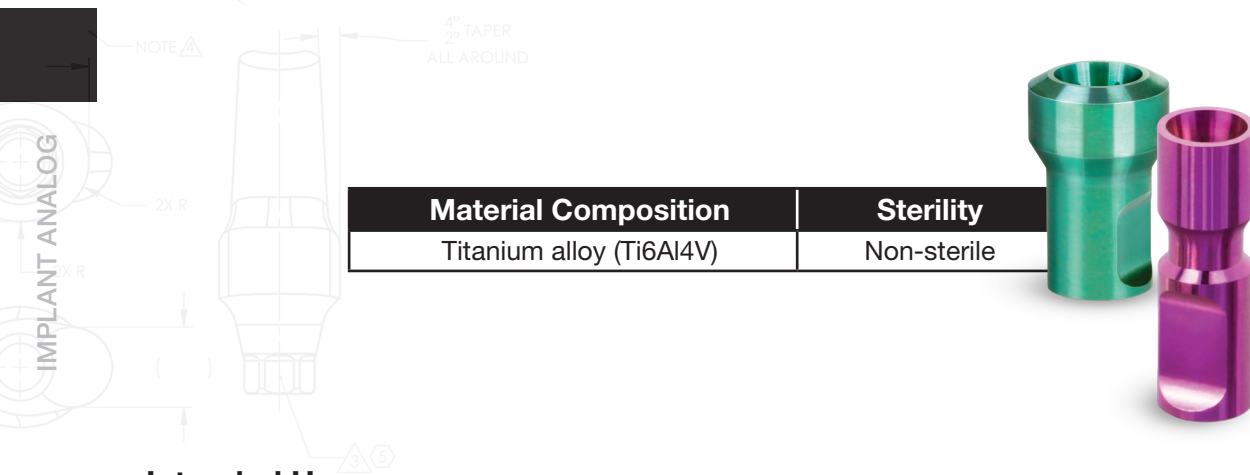

Material Composition	Sterility
Titanium alloy (Ti6Al4V)	Non-sterile

Intended Use

Glidewell HT Implant Analogs are to be incorporated in the production of a working model to replicate the position and orientation of implants seated in the patient's mouth.

Contraindications

Glidewell HT Implant Analogs are not intended for use in the oral environment.

Implant Analog Procedure

■ Select a Glidewell HT Implant Analog

Select the appropriate Glidewell HT Implant Analog based on the diameter of the implant seated in the patient's mouth.

■ Attach the Implant Analog

- 1) Follow the elastomeric impression procedure for the desired transfer technique (open-tray or closed-tray) using its associated impression coping.
- 2) Mount the Glidewell HT Implant Analog on the impression coping. Be sure the analog seats flush against the impression coping, and the non-rotational features of the connection are fully engaged.
- 3) Fasten the impression coping to the implant analog by using the appropriate driver to hand-tighten the retaining screw.
- 4) Proceed with the fabrication of a stone model using standard laboratory techniques. Upon separation, the implant analog is a part of the master cast replicating the position of the implant seated in the oral cavity.

Glidewell HT™ Implant Titanium Abutment

Product Description

Glidewell HT™ Implant Titanium Abutments are prefabricated, screw-retained intraoral abutments intended to be connected directly to an endosseous implant for retention of a cemented dental prosthesis. They may be indicated for single- and multiple-tooth restorations. Titanium abutments are precisely machined from titanium alloy and attached to the implant fixture with a titanium screw. For use in any region of the mouth, they contain a standard, circular emergence profile and straight abutment body available in 4.5 mm and 6 mm vertical height options. Each abutment is specific to the restorative platform of the seated implant.

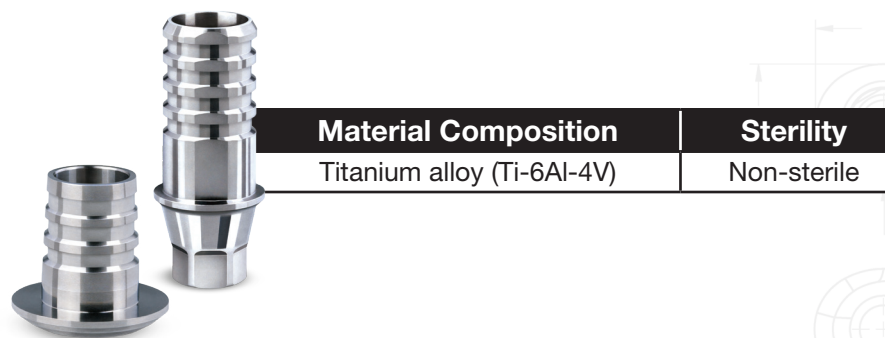

Each Glidewell HT Implant Titanium Abutment requires a Glidewell HT™ Implant Titanium Screw (sold separately).

Intended Use

Glidewell HT Implant Titanium Abutments are prefabricated prosthetic components directly connected to endosseous dental implants, and are intended for use as an aid in prosthetic rehabilitation.

Contraindications

The following conditions would contraindicate use of Glidewell HT Implant Titanium Abutments:

- Wall thickness less than 0.5 mm
- Gingival margin diameter less than 0.5 mm wider than the implant
- Angle corrections of more than 30 degrees
- Less than 0.5 mm margin height
- Less than 4.0 mm abutment post height above the gingival collar

Restorative Procedure with Titanium Abutments

■ Capture Implant Placement

Take an implant-level impression utilizing the preferred technique (direct, indirect, or intraoral scan). Submit the impression to the laboratory.

CAD/CAM Preparation

■ Laboratory – Design the Restoration

- 1) Create a soft tissue study model from an implant-level impression.
- 2) Select the appropriate laboratory scan bodies to capture the implant angulation, position, and abutment connection orientation. Follow manufacturer instructions to obtain all necessary scans to construct an accurate, complete 3-D model.
- 3) Design the abutment according to the patient's clinical needs, taking care to ensure adequate support for the eventual restoration, including appropriate interproximal and occlusal space. Produce a digital design file.
- 4) Send the digital design file to a milling center to manufacture the patient-specific implant abutment.

Glidewell HT™ Implant Titanium Abutment

■ Milling Center — Fabricate the Restoration

- 1) Select the appropriate Glidewell HT™ Abutment Blank based on the system, platform size, location, and occlusal clearance of the implant seated in the patient's mouth.
- 2) Fabricate the restoration using CAD/CAM techniques. Veneer as necessary. If a screw-retained hybrid restoration is indicated, fabricate the superstructure (i.e., zirconia coping or crown) and lute it to the titanium abutment. The superstructure is to be bonded to the titanium abutment using MonoCem® Self-Adhesive Resin Cement (Shofu Dental Corporation; San Marcos, Calif.).

Non-CAD/CAM Preparation

■ Laboratory — Fabricate the Restoration

- 1) Follow pouring procedures for the appropriate die stone to produce a working model and articulate with a bite registration.
- 2) Select the appropriate Glidewell HT Implant Titanium Abutment based on platform size, location, and occlusal clearance of the Glidewell HT Implant seated in the patient's mouth.
- 3) Seat the abutment completely into the implant analog on the working model, making sure that the anti-rotational features of the connection interface are fully engaged and the contours of the emergence profile (if applicable) are esthetically oriented.
- 4) Insert a Titanium Screw into the abutment's screw access hole and hand-tighten using the Glidewell HT™ Implant Prosthetic Driver.
- 5) Fabricate the restoration using conventional casting techniques. Veneer as necessary. If a screw-retained hybrid restoration is indicated, lute the zirconia coping to the titanium abutment. The ceramic crown is to be bonded to the titanium abutment using MonoCem Self-Adhesive Resin Cement.

Manual Adjustment

⚠ NOTE: Due to the high thermal conductivity of titanium, titanium abutments should not be modified in the oral cavity. Any necessary modifications should be made extraorally.

- 1) Seat the abutment completely into an implant analog retained by an analog holder or the implant analog captured in the working model, making sure that the anti-rotational features of the connection interface are fully engaged and the contours of the emergence profile (if applicable) are esthetically oriented.
- 2) Insert a Glidewell HT Titanium Screw into the abutment's screw access hole and hand-tighten using the appropriate driver.
- 3) Using a fine-diamond or carbide bur, modify the abutment as needed.
- 4) With a silicone-based rubber wheel or point, refine the abutment along the margins.

Deliver the Final Restoration

- 1) Seat the titanium abutment or screw-retained hybrid restoration completely into the implant, making sure that the anti-rotational features of the connection interface are fully engaged and the contours of the sculpted emergence profile are esthetically oriented.
- 2) Insert a Titanium Screw into the screw access hole and hand-tighten using the Glidewell HT Implant Prosthetic Driver. It is strongly recommended that a radiograph of the connection site be taken to confirm complete seating of the abutment or hybrid restoration before proceeding.
- 3) Using the Glidewell HT Implant Prosthetic Driver in conjunction with a properly metered torque wrench, tighten the abutment or hybrid restoration to the recommended torque value (see "Torque Values" on page 8).
- 4) Fill the screw access hole with cotton, Teflon tape, gutta-percha, or other suitable material.
- 5) If the restoration is of a screw-retained hybrid design, cover the screw access hole with flowable composite, and cure. Otherwise, follow applicable cementation procedures to affix the definitive restoration to the abutment.

Glidewell HT™ Implant Esthetic Abutment

Product Description

Glidewell HT™ Implant Esthetic Abutments are prefabricated, screw-retained intraoral abutments intended to be connected directly to an endosseous implant for retention of a cemented dental prosthesis. They may be indicated for single- and multiple-tooth restorations. Esthetic abutments are precisely machined from titanium alloy and attached to the implant fixture with a titanium screw. Unlike the circular emergence profile of standard stock abutments, esthetic abutments are manufactured with a tapered emergence profile for more natural-looking contouring of the soft tissue at the implant site. Each esthetic abutment is specific to the restorative platform of the seated implant, and anatomically designed for the connection site's region on the ridge (anterior or posterior). In addition to the standard, straight abutment body, angled abutment bodies, produced with a 15 degree slope of one hemisphere to compensate for an undesirable path of insertion resulting from excessive implant angulation, are available.

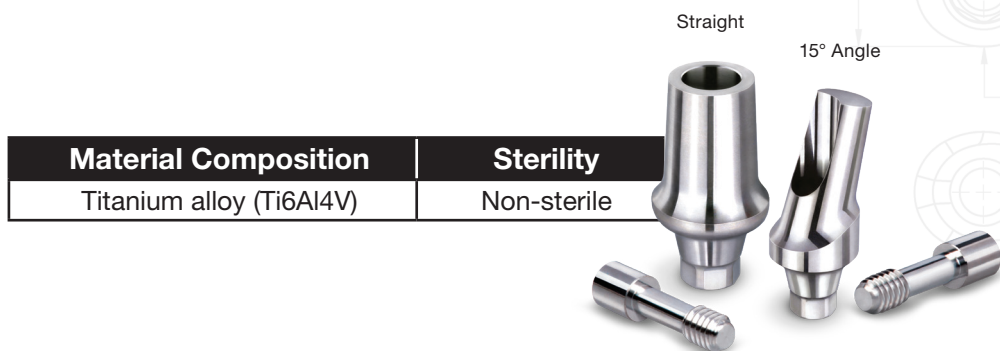

Each Glidewell HT Implant Esthetic Abutment is packaged with a separate retaining screw (Glidewell HT™ Implant Titanium Screw).

Intended Use

Glidewell HT Implant Esthetic Abutments are prefabricated prosthetic components directly connected to endosseous dental implants, and are intended for use as an aid in prosthetic rehabilitation.

Contraindications

The following conditions would contraindicate use of Glidewell HT Implant Esthetic Abutments:

- Wall thickness less than 0.5 mm
- Gingival margin diameter less than 0.5 mm wider than the implant
- Angle corrections of more than 30 degrees
- Less than 0.5 mm margin height
- Less than 4.0 mm abutment post height above the gingival collar

Angled abutments should not be used to restore small-diameter implants (less than or equal to 3.0 mm) in the posterior region.

Glidewell HT™ Implant Esthetic Abutment

Restorative Procedure with Esthetic Abutments

■ Capture Implant Placement

Take an implant-level impression utilizing the preferred technique (direct, indirect, or intraoral scan). Submit the impression to the laboratory.

CAD/CAM Preparation

■ Laboratory – Design the Restoration

- 1) Create a soft tissue study model from an implant-level impression.
- 2) Select the appropriate laboratory scan bodies to capture the implant angulation, position, and abutment connection orientation. Follow manufacturer instructions to obtain all necessary scans to construct an accurate, complete 3-D model.
- 3) Design the abutment according to the patient's clinical needs, taking care to ensure adequate support for the eventual restoration, including appropriate interproximal and occlusal space. Produce a digital design file.
- 4) Send the digital design file to a milling center to manufacture the patient-specific implant abutment.

■ Milling Center – Fabricate the Restoration

- 1) Select the appropriate Glidewell HT™ Abutment Blank based on the system, platform size, location, and occlusal clearance of the implant seated in the patient's mouth.
- 2) Fabricate the restoration using CAD/CAM techniques. Veneer as necessary. If a screw-retained hybrid restoration is indicated, fabricate the superstructure (i.e., zirconia coping or crown) and lute it to the titanium abutment. The superstructure is to be bonded to the titanium abutment using MonoCem® Self-Adhesive Resin Cement (Shofu Dental Corporation; San Marcos, Calif.).

Non-CAD/CAM Preparation

■ Laboratory – Fabricate the Restoration

- 1) Follow pouring procedures for the appropriate die stone to produce a working model and articulate with a bite registration.
- 2) Select the appropriate Glidewell HT Implant Titanium Abutment based on platform size, location, and occlusal clearance of the Glidewell HT Implant seated in the patient's mouth.
- 3) Seat the abutment completely into the implant analog on working model, making sure that the anti-rotational features of the connection interface are fully engaged and the contours of the emergence profile (if applicable) are esthetically oriented.
- 4) Insert a Titanium Screw into the abutment's screw access hole and hand-tighten using the Glidewell HT prosthetic driver.
- 5) Fabricate the restoration using conventional casting techniques. Veneer as necessary. If a screw-retained hybrid restoration is indicated, lute the zirconia coping to the titanium abutment. The ceramic crown is to be bonded to the titanium abutment using MonoCem Self-Adhesive Resin Cement.

Glidewell HT™ Implant Esthetic Abutment

Manual Adjustment

⚠ NOTE: Due to the high thermal conductivity of titanium, titanium abutments should not be modified in the oral cavity. Any necessary modifications should be made extraorally.

- 1) Seat the abutment completely into an implant analog retained by an analog holder or the implant analog captured in the working model, making sure that the anti-rotational features of the connection interface are fully engaged and the contours of the emergence profile (if applicable) are esthetically oriented.
- 2) Insert a Glidewell HT Titanium Screw into the abutment's screw access hole and hand-tighten using the appropriate driver.
- 3) Using a fine-diamond or carbide bur, modify the abutment as needed.
- 4) With a silicone-based rubber wheel or point, refine the abutment along the margins.

Deliver the Final Restoration

- 1) Seat the titanium abutment or screw-retained hybrid restoration completely into the implant, making sure that the anti-rotational features of the connection interface are fully engaged and the contours of the sculpted emergence profile are esthetically oriented.
- 2) Insert a Titanium Screw into the screw access hole and hand-tighten using the Glidewell HT prosthetic driver. It is strongly recommended that a radiograph of the connection site be taken to confirm complete seating of the abutment or hybrid restoration before proceeding.
- 3) Using the Glidewell HT prosthetic driver in conjunction with a properly metered torque wrench, tighten the abutment or hybrid restoration to the recommended torque value (see "Torque Values" on page 8).
- 4) Fill the screw access hole with cotton, Teflon tape, gutta-percha, or other suitable material.
- 5) If the restoration is of a screw-retained hybrid design, cover the screw access hole with flowable composite, and cure. Otherwise, follow applicable cementation procedures to affix the definitive restoration to the abutment.

Glidewell HT™ Implant UCLA Abutment

Product Description

Glidewell HT™ Implant Universal Clearance-Limited Abutments (UCLAs) are indicated for laboratory use to manually create an implant-level custom abutment for a cement- or screw-retained restoration. UCLAs are precisely machined and attached to the implant fixture (or implant analog) with a titanium screw or guide pin. The plastic sleeve on top of the abutment provides a supporting structure on which to wax the restoration. Each UCLA is specific to the restorative platform of the corresponding implant.

Plastic UCLAs are used to create diagnostic wax-ups (try-in prostheses), whereas *gold* UCLAs are used to fabricate final custom abutments. Each is available with engaging or non-engaging connection interface. *Engaging* UCLAs are indicated for single-unit restorations to prevent rotation. A *non-engaging* UCLA is indicated for multi-unit bridges to allow passive path of insertion without anti-rotational restrictions.

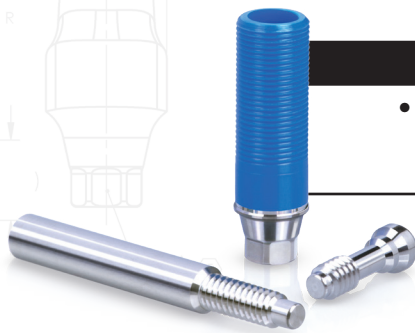

Material Composition	Sterility
<ul style="list-style-type: none">• Gold alloy (60% Au, 20% Pd, 19% Pt)• Polymers (acetal copolymer)• Titanium alloy (Ti6Al4V)	Non-sterile

Each Glidewell HT Implant UCLA is packaged with a guide pin (Glidewell HT™ Implant Guide Pin) and separate retaining screw (Glidewell HT™ Implant Titanium Screw). The guide pin should be used during the fabrication process. The titanium screw is used while fitting the diagnostic wax-up, or for retaining a definitive restoration.

Intended Use

Glidewell HT Implant Universal Clearance Limited Abutments (UCLAs) are prefabricated prosthetic components directly connected to endosseous dental implants, and are intended for use as an aid in prosthetic rehabilitation.

Contraindications

Contact between Glidewell HT Implant *Plastic* UCLAs and soft tissue should not exceed a one (1) hour duration

The following conditions would contraindicate use of Glidewell HT Implant *Gold* UCLAs:

- Wall thickness less than 0.5 mm
- Gingival margin diameter less than 0.5 mm wider than the implant
- Angle corrections of more than 30 degrees
- Less than 0.5 mm margin height
- Less than 4.0 mm abutment height

Angled abutments should not be used to restore small-diameter implants (less than or equal to 3.0 mm) in the posterior region.

Glidewell HT™ Implant UCLA Abutment

Casting Custom Abutments with Gold UCAs

■ Select a Glidewell HT Implant Gold UCLA Abutment

Select the appropriate gold Glidewell HT Implant UCLA based on the implant diameter and connection interface (engaging or non-engaging).

■ Produce the Working Model

- 1) For elastomeric impressions created with the closed-tray technique, confirm that the transfer copings are placed appropriately within the elastomeric impression.
- 2) Ensure each captured transfer coping is fitted with a fully seated implant analog, and that there is no lateral movement of the analog. If movement is observed, a new impression is required.
- 3) Follow pouring procedures for the appropriate die stone to produce a working model. It is highly recommended that a soft-tissue model be fabricated by syringing soft-tissue material around the analog-coping interface prior to pouring the die stone.
- 4) For impressions created with the open-tray technique, unscrew and remove the guide pin from the underside of the impression tray before separating the model from the impression.

■ Wax Up the Definitive Restoration

- 1) Seat the gold Glidewell HT Implant UCLA onto the implant analog in the stone model and hand-tighten using the Glidewell HT Implant Guide Pin (provided) with the appropriate driver. If the UCLA is engaging, be sure the interlocking features are fully engaged.
- 2) Make shape and height adjustments to the plastic sleeve as necessary for occlusal spacing and retention requirements.
- 3) Using laboratory waxing procedures, add wax to the exterior of the UCLA plastic sleeve to create the desired emergence profile, margins, and contours.

⚠ NOTE: The Glidewell HT Implant Guide Pin should be used prior to waxing to ensure the screw access channel remains open.

- 4) Once satisfied with the wax form, sprue the finished investment pattern. Be sure to sprue so that the waxing sleeve will stand perpendicular to the base of the investment ring.

■ Cast the UCLA Wax-up

- 1) Unscrew and remove the investment pattern from the stone model. Take care to ensure that the rotation of the guide pin during removal does not alter the sculpted shape of the wax-up.
- 2) Carefully examine the investment pattern to confirm the platform-specific connection is free of wax and other debris.
- 3) Follow investment procedures to invest the wax-up. When pouring the investment material, pay special attention to ensure that the investment flows up and through the screw access channel.
- 4) Follow casting procedures, observing all material specifications and equipment instructions.
- 5) Chemically divest the abutment. Do not use sandblasting divestment techniques, as the coarse grains will alter the machined precision of the platform-specific base. Polish as necessary.

UCLA ABUTMENT

Glidewell HT™ Implant UCLA Abutment

■ Finish the UCLA Restoration

Follow procedures for the final restoration material to bond the restorative layers to the custom abutment.

Creating a Diagnostic Wax-up with Plastic UCAs

■ Select a Glidewell HT Implant Plastic UCLA Abutment

Select the appropriate plastic Glidewell HT Implant UCLA based on the implant diameter and connection interface (engaging or non-engaging).

■ Produce the Working Model

- 1) For elastomeric impressions created with the closed-tray technique, confirm that the transfer copings are placed appropriately within the elastomeric impression.
- 2) Ensure each captured transfer coping is fitted with a fully seated implant analog, and that there is no lateral movement of the analog. If movement is observed, a new impression is required.
- 3) Follow pouring procedures for the appropriate die stone to produce a working model. It is highly recommended that a soft-tissue model be fabricated by syringing soft-tissue material around the analog-coping interface prior to pouring the die stone.
- 4) For impressions created with the open-tray technique, unscrew and remove the guide pin from the underside of the impression tray before separating the model from the impression.

■ Create the Diagnostic Wax-up

- 1) Seat the plastic Glidewell HT Implant UCLA onto the implant analog in the stone model and hand-tighten the Glidewell HT Implant Guide Pin (provided) with the appropriate driver. If the UCLA is engaging, be sure the interlocking features are fully engaged.
- 2) Make shape and height adjustments to the plastic sleeve as necessary for occlusal spacing and retention requirements.
- 3) Using laboratory waxing procedures, add wax to the exterior of the UCLA plastic sleeve to create the desired emergence profile, margins, contours, occlusion, and esthetics for the try-in prosthesis.

⚠ NOTE: The Glidewell HT Implant Guide Pin should be used prior to waxing to ensure the screw access channel remains open.

Glidewell HT™ Implant Titanium Screw/Guide Pin

Product Description

Glidewell HT™ Implant Titanium Screws and Glidewell HT™ Implant Guide Pins are threaded fasteners used to attach implant prosthetic components to dental implant fixtures or implant analogs on a temporary or long-term basis. Each screw or guide pin is precisely machined from titanium alloy and is specific to the system or the restorative platform of the seated implant.

Titanium screws are generally reserved for the long-term retention of a finished provisional or definitive restoration in the oral environment. A screw used to attach prosthetic components to an implant analog in a working model during laboratory fabrication processes should be replaced with a new screw upon final delivery of the definitive restoration. *Guide pins* are reserved for provisional applications, to attach prosthetic components to an implant analog captured in a working model during laboratory fabrication processes, or, after sterilization, to temporarily attach a Glidewell HT™ Implant Open-Tray Impression Coping to an endosseous dental implant during a direct transfer procedure.

Material Composition	Sterility
Titanium alloy (Ti6Al4V)	Non-sterile



Intended Use

Glidewell HT Implant Titanium Screws are indicated for the temporary or long-term retention of implant restorative components to an endosseous dental implant fixture seated in the oral environment, or to an implant analog. Glidewell HT Implant Guide Pins are indicated for the temporary retention of implant restorative components to an implant analog, or, after sterilization, to temporarily attach a Glidewell HT Implant Open-Tray Impression Coping to an endosseous dental implant during a direct transfer procedure.

Contraindications

Glidewell HT Implant Guide Pins are not intended for use in the oral environment, except to temporarily attach a Glidewell HT Implant Open-Tray Impression Coping to an endosseous dental implant during a direct transfer procedure. Any guide pin placed intraorally should be sterilized prior to use.

Attachment Procedure

■ Select a Screw or Guide Pin

Select the appropriate Glidewell HT Implant Titanium Screw or Glidewell HT Implant Guide Pin based on the intended application, as well as the diameter of the implant or implant analog to which the restorative component will be attached.



Glidewell HT™ Implant Titanium Screw/Guide Pin _____

■ Attach the Restorative Component

- 1) Properly seat the restorative component against the implant fixture or implant analog to which it will be attached.
- 2) Insert the Glidewell HT Implant Titanium Screw or Glidewell HT Implant Guide Pin through the screw access hole of the restorative component and into the internal connection cavity of the implant fixture or implant analog. Make sure the screw or guide pin enters at the same angle as the implant or analog to avoid potential damage that may result from cross-threading.
- 3) Rotate the screw or guide pin clockwise until engaged with the internal threads of the implant/analog connection cavity.
- 4) Using the selected driver in conjunction with a properly metered torque wrench, advance threaded delivery of the screw or guide pin until the restorative component is fully seated against the implant/analog platform. Hand-tighten only, if indicated. Otherwise, tighten to the recommended torque value (see “Torque Values” on page 8).
- 5) Verify complete seating of the restorative component against the implant/analog platform. Utilize radiography to do so, if clinically appropriate.

Retrieval Procedure

■ Detach the Restorative Component

- 1) If applicable, remove any overlying restoration or other material preventing access to the head of the Glidewell HT Implant Titanium Screw or Glidewell HT Implant Guide Pin.
- 2) Insert the Glidewell HT Implant Prosthetic Driver into the screw access hole to engage the instrumentation port of the screw or guide pin.
- 3) Rotate the screw or guide pin counter-clockwise until completely disengaged from the internal threads of the implant/analog connection cavity.
- 4) Carefully remove both the screw or guide pin and the restorative component as it is loosened from the implant/analog platform.

Glidewell HT™ Implant Multi-Unit Abutment

Product Description

Glidewell HT™ Implant Multi-Unit Abutments are prefabricated, screw-retained intraoral abutments intended to be connected directly to endosseous implants in partially or fully edentulous patients for the retention of cast or milled bar overdentures. For implant-supported prostheses, six or more implants are recommended in the maxilla, four or more in the mandible. If clinical conditions dictate fewer implants, an implant-retained, tissue-supported prosthesis is indicated. Multi-unit abutments are precisely machined from titanium alloy, and are available with a variety of collar heights to achieve optimal emergence from shallow or deep gingival wells. Each Glidewell HT Implant Multi-Unit Abutment is delivered sterile, with a carrier color-coded to indicate the restorative platform of the seated implant.

Straight multi-unit abutments lack any anti-rotational features at the implant-abutment interface. The apical portion of a straight multi-unit abutment is threaded for integration with the internal cavity of a seated implant. For abutment delivery, the occlusal surface features a male hex head compatible with the multi-unit driver recommended by the implant manufacturer.

Angled multi-unit abutments of 17 degrees or 30 degrees enable clinicians to compensate for the divergence of seated implants or to otherwise accommodate an angled path of insertion. Angled multi-unit abutments feature an anti-rotational connection interface specific to the matching implant platform, and are attached to the implant fixture with an angled multi-unit abutment screw compatible with the restorative instrumentation of the Glidewell HT Implant System.

Both straight and angled multi-unit abutments feature a female connection port at the coronal apex, to allow for the attachment of a screw-retained or fixed-removable dental prosthesis with a multi-unit restorative screw (Prosthetic Screw).



Material Composition

Titanium alloy (Ti6Al4V)

Sterility

Sterile

Each angled Glidewell HT Implant Multi-Unit Abutment is packaged with a separate retaining screw (Glidewell HT™ Implant Angled Multi-Unit Abutment Screw).

Intended Use

Glidewell HT Implant Multi-Unit Abutments are prosthetic components directly connected to endosseous dental implants and intended to provide support and retention for multi-unit screw-retained restorations. A 30-degree angled multi-unit abutment must be used within 45 degrees of parallelism for a splinted restoration. A 17-degree angled multi-unit abutment must be used within 32 degrees of parallelism for a splinted restoration.

Contraindications

The following conditions would contraindicate use of Glidewell HT Implant Multi-Unit Abutments:

- Greater than 45 degrees divergence from parallel for a splinted restoration when using 30-degree angled multi-unit abutments
- Greater than 32 degrees divergence from parallel for a splinted restoration when using 17-degree angled multi-unit abutments

Angled abutments should not be used to restore small-diameter implants (less than or equal to 3.0 mm) in the posterior region.

Glidewell HT™ Implant Multi-Unit Abutment

Implant Orientation

The axial tilt of a Glidewell HT Implant Angled Multi-Unit Abutment (angular divergence from path of insertion) is designed and manufactured to lie along a plane of the implant connection geometry, as opposed to a corner or junction. To maximize the angle-correcting attributes of the multi-unit abutment, be sure to rotate the implant upon final seating so that one side of the internal connection geometry (flat) is oriented to serve as the base of angulation, in accordance with the restorative treatment plan.

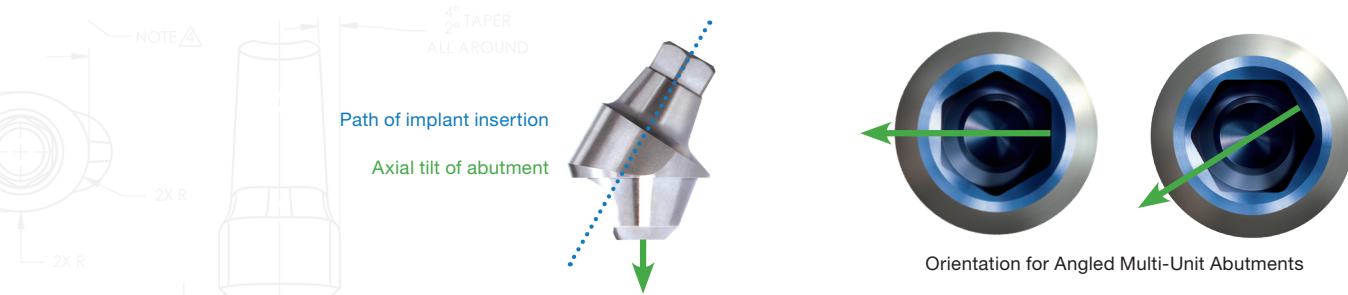

Restorative Procedure with Multi-Unit Abutments

■ Place the Multi-Unit Abutment

- 1) Select the appropriate Glidewell HT Implant Multi-Unit Abutment based on platform size, endosseous implant angle, and depth of the soft-tissue well.
- 2) Retrieve the abutment from its packaging. To maintain the sterility of the multi-unit abutment, be careful to handle only by the carrier.

FOR STRAIGHT MULTI-UNIT ABUTMENTS:

- 3) Using the carrier, seat the abutment into the implant and hand-tighten. Remove the carrier by pulling the apex of the carrier toward the facial. It is strongly recommended that a radiograph of the connection site be taken to confirm complete seating of the abutment before proceeding.
- 4) Using the appropriate driver in conjunction with a properly metered torque wrench, tighten the multi-unit abutment to the recommended torque value (see “Torque Values” on page 8).

FOR ANGLED MULTI-UNIT ABUTMENTS:

- 3) Using the carrier, seat the abutment into the implant until the anti-rotational features of the connection interface are engaged. Lift and rotate as necessary to orient the angle in the required direction.
- 4) Hand-tighten the Glidewell HT Implant Angled Multi-Unit Abutment Screw using the Glidewell HT Implant Prosthetic Driver. Turn the carrier counterclockwise to unscrew the carrier from the abutment. It is strongly recommended that a radiograph of the connection site be taken to confirm complete seating of the abutment before proceeding.
- 5) Using the appropriate driver in conjunction with a properly metered torque wrench, tighten the multi-unit abutment to the recommended torque value (see “Torque Values” on page 8).

■ Delayed Loading of Multi-Unit Abutments

- 1) If the initial stability of the seated implant is insufficient for loading, cover each Glidewell HT Implant Multi-Unit Abutment with a temporary healing cap (Inclusive® Multi-Unit Temporary Healing Cap) and hand-tighten with a prosthetic screw (Inclusive® Prosthetic Screw), using the appropriate driver. Do not overtighten.

Glidewell HT™ Implant Multi-Unit Abutment

- 2) Using the patient's existing denture or other prosthesis, relieve the area directly above the placement of each temporary healing cap until the denture rests on the ridge.
- 3) Follow procedures to reline the denture over the temporary healing caps, using soft reline material only. The temporized denture can be used during a healing phase until the implants obtain sufficient load-bearing stability.

■ Closed-Tray Impression Procedure (Indirect Transfer) for Multi-Unit Abutments

- 1) Ensure gingival tissue is sufficiently withdrawn to avoid pinching.
- 2) Twist the appropriate closed-tray multi-unit impression coping (Inclusive® Multi-Unit Impression Coping, Closed-Tray) onto each Glidewell HT Implant Multi-Unit Abutment until fully seated. Hand-tighten only. Overtightening may result in loosening of the multi-unit abutments when the copings are removed.
- 3) Follow documentation for the chosen impression material to take a full-arch elastomeric impression.
- 4) Once the impression material has set within the closed tray, remove the tray from the patient's ridge. Each closed-tray multi-unit impression coping will remain connected to its corresponding abutment.
- 5) Unscrew each closed-tray multi-unit impression coping from its corresponding multi-unit abutment and remove. Twist each closed-tray impression coping onto the appropriate multi-unit abutment analog (Inclusive® Multi-Unit Abutment Analog) and hand-tighten.
- 6) Reposition each closed-tray multi-unit impression coping into its corresponding depression in the impression tray and press firmly to engage. The multi-unit abutment analogs should protrude from the impression.
- 7) Proceed with the fabrication of a stone model using standard laboratory techniques. Upon separation, the multi-unit abutment analogs are a part of the master cast replicating the position of each multi-unit abutment in the oral cavity.

■ Open-Tray Impression Procedure (Direct Transfer) for Multi-Unit Abutments

- 1) Ensure gingival tissue is sufficiently withdrawn to avoid pinching.
- 2) Seat the appropriate open-tray multi-unit impression coping (Inclusive® Multi-Unit Impression Coping, Open-Tray) onto each Glidewell HT Implant Multi-Unit Abutment.
- 3) Slide the appropriate guide pin (Inclusive® Multi-Unit Guide Pin) into the open-tray multi-unit impression coping. Turn the guide pin clockwise to hand-tighten. Overtightening may result in loosening of the multi-unit abutment when the guide pin is removed.
- 4) Follow documentation for the chosen impression material to take a full-arch elastomeric impression.
- 5) Once the impression material has set within the open tray, unscrew and remove the guide pin with the tray still in place on the arch.
- 6) Remove the tray from the patient's ridge. The open-tray multi-unit impression copings should be captured by the impression material.
- 7) Mount the appropriate abutment analog (Inclusive® Multi-Unit Abutment Analog) onto each open-tray multi-unit impression coping captured within the impression, and refasten using the guide pin.
- 8) Proceed with the fabrication of a stone model using standard laboratory techniques. Upon separation, the multi-unit abutment analogs are a part of the master cast replicating the position of each multi-unit abutment in the oral cavity.

Glidewell HT™ Implant Multi-Unit Abutment

■ Temporize with Multi-Unit Abutments

- 1) Seat the appropriate multi-unit temporary abutment (Inclusive® Multi-Unit Titanium Temporary) onto each Glidewell HT Implant Multi-Unit Abutment and hand-tighten with a prosthetic screw (Inclusive® Multi-Unit Prosthetic Screw) using the Glidewell HT Implant Prosthetic Driver.
- 2) Using an existing denture or other prosthesis, place a hole in the position directly above the placement of each multi-unit titanium temporary. The holes should puncture all the way through the prosthesis.
- 3) Resting the denture on the ridge with the titanium temporaries protruding from the apex, carefully fill the hole around each titanium temporary with acrylic, flowable composite, or other material suitable for securing the temporary to the denture. Follow procedures to cure the material, being careful to keep the temporary's screw access channel free of adhesive.
- 4) Remove the prosthetic screw from each titanium temporary and remove the denture. The temporaries should be captured within the denture.
- 5) Modify the denture as necessary. Grind any protruding titanium from the upper side of the denture. Fill any voids around the base of each titanium temporary on the underside of the denture with acrylic, flowable composite, or other suitable material, and cure.
- 6) Reseat the temporary denture onto the ridge and replace the prosthetic screw into the multi-unit titanium temporaries. Using the appropriate driver in conjunction with a properly metered torque wrench, tighten the prosthetic screws to 15 Ncm.
- 7) Fill the screw access channels with gutta-percha, silicone, or other suitable temporary material.

■ Laboratory – Fabricate the Stone Working Model

- 1) For impressions captured with the closed-tray (indirect) technique, ensure that the closed-tray multi-unit impression copings are placed appropriately within the elastomeric impression.
- 2) Ensure each captured closed-tray multi-unit impression coping is fitted with a fully seated multi-unit abutment analog, and that there is no lateral movement of the analog. If movement is observed, a new impression is required.
- 3) Follow pouring procedures for the appropriate die stone to produce a working model. It is highly recommended that a soft-tissue model be fabricated by syringing soft-tissue material around the analog-coping interface prior to pouring the die stone.
- 4) For impressions captured with the open-tray (direct) technique, unscrew and remove the guide pin from the underside of the impression tray before separating the model from the impression.

■ Laboratory – Create the Verification Index

- 1) Seat an Inclusive® Multi-Unit Gold/Plastic Coping onto each analog captured in the stone working model and hand-tighten with an Inclusive® Multi-Unit Guide Pin using the appropriate driver.
- 2) Remove the plastic sleeve from each coping by pulling straight up on the sleeve.
- 3) Lute two adjacent copings together at the non-tapered coronal aspect with light-cure composite resin or autopolymerizing acrylic resin.
- 4) Once cured, separate the resin connections with a high-speed disc bur or Bard-Parker® knife. Repeat for each pair of adjacent copings.
- 5) Once all copings are sectioned, confirm all guide pins are hand-tightened and lute all sections together by adding a small amount of resin to each separation point.

Glidewell HT™ Implant Multi-Unit Abutment

- 6) Remove the guide pins and the verification index. Send the verification index and the prosthetic screws packaged with the Inclusive Multi-Unit Gold/Plastic Copings to the restorative dentist.

■ Confirm a Passive Fit with the Verification Index

- 1) Place the verification index on the multi-unit abutments.
- 2) Hand-tighten either of the distal-most copings into the multi-unit abutment using a prosthetic screw and the appropriate driver. Confirm that the remaining copings sit passively and completely on their respective abutments.
- 3) Fasten each of the remaining copings, beginning with the distal and working forward by alternating sides. Hand-tighten only.
- 4) If a passive fit is achieved, an accurate transfer has been recorded. Remove the verification index.

■ Laboratory – Fabricate a Record Base and Occlusal Rim

- 1) Re-attach the verification index to the working model with a hand-tightened guide pin for each coping. The verification index will act as the framework for the record base.
- 2) Follow instructions for the record base material to form and cure the base around the index framework. Be sure the material conforms fully to the contours of the edentulous arch. The base should fit tightly around the protruding guide pins and fill in any gaps between the framework and the ridge.
- 3) Follow procedures to build a wax occlusal rim on top of the record base.
- 4) Send the record base / occlusal rim fixture to the dentist, still fastened to the working cast.

■ Take the Occlusal Rim Bite Registration

- 1) Remove the occlusal rim from the working cast by twisting and removing the guide pins straight up through the access holes.
- 2) Seat the record base onto the multi-unit abutments on the patient's ridge. Hand-tighten the record base and occlusal rim fixture to the abutments with the prosthetic screws, using the appropriate driver.

⚠ NOTE: The alignment procedure may require multiple insertions and removals of the occlusal rim. At least two screws should be fastened during registration to ensure proper fit.

- 3) Using a heated Bard-Parker® knife, index the midline and smile line with a notch across the facial aspect of each occlusal rim.
- 4) Modify extraorally as needed with a heated Bard-Parker knife to set the vertical dimension of occlusion.
- 5) Using a heated Bard-Parker knife, cut a shallow triangular notch into the occlusal surface of each occlusal rim's posterior regions. If the patient is fully edentulous, be sure the notches in the maxillary and mandibular occlusal rims are slightly offset for successful indexing of the bite registration.
- 6) With the occlusal rim securely fastened by the prosthetic screws, syringe sufficient elastomeric bite registration material onto the rim and create the bite registration.
- 7) Remove the occlusal rim from the patient's mouth. Replace and fasten to the working cast with the guide pins, and return the working cast, occlusal rims, and bite registration to the laboratory.

■ Laboratory – Fabricate the Wax Try-In

With the record base articulated via the interocclusal record, follow procedures to mount the wax try-in denture teeth onto the stabilized record base.

Glidewell HT™ Implant Multi-Unit Abutment

■ Try-in the Restoration

- 1) Seat the wax try-in onto the multi-unit abutments on the patient's ridge and hand-tighten with the prosthetic screws.
- 2) Modify as needed to obtain the desired esthetics, phonetics, and occlusion.
- 3) Remove the wax try-in and return the approved apparatus to the laboratory.

■ Laboratory – Fabricate the Final Prosthesis

- 1) Follow plaster or silicone casting procedures to fabricate a matrix of the approved wax try-in.
- 2) Using the wax try-in as the template, follow procedures to create the final prosthesis. If the prosthesis will be bar-retained, the bar should be fabricated concurrently with the prosthesis to ensure proper fit and adequate retention.

■ Laboratory – Fabricate a Retention Bar

Fabricate a retention bar for the prosthesis according to the desired method. Specific procedures for fabricating a cast bar, an immediate bar, and a CAD/CAM bar are outlined separately below.

■ Laboratory – Fabricate a Cast Bar

- 1) Remove the try-in/prosthesis from the working model and attach an Inclusive® Multi-Unit Gold/Plastic Coping with plastic burnout sleeve to each multi-unit abutment analog. Hand-tighten with the Inclusive® Multi-Unit Guide Pin.
- 2) Using the plaster/silicone matrix (created from the approved wax try-in) as a guide for size and position, follow waxing procedures to wax the bar pattern around the copings and plastic sleeves. The bar pattern should fit well within the matrix's borders to assure adequate room in the final prosthesis for all bar components without sacrificing excessive material thickness.
- 3) Unscrew the guide pins and remove the wax bar pattern from the working model. Follow procedures to invest, burn out, and cast the bar with the appropriate alloy.
- 4) Finish the cast bar by divesting, refining as needed, and polishing. When making alterations, be sure not to adjust the incorporated coping's multi-unit abutment connection regions. Changes to these machined specifications will result in improper seating and/or decreased retention.

■ Laboratory – Fabricate an Immediate Bar

- 1) Remove the try-in/prosthesis from the working model and attach an Inclusive® Multi-Unit Gold Bar Coping to each multi-unit abutment analog. Hand-tighten with an Inclusive® Multi-Unit Guide Pin.
- 2) Follow procedures to measure, lute, and solder bar segments to the bar copings.

⚠ NOTE: If desired, measurement and luting of the bar segments can be performed intraorally, and a stone working model produced from the luted bar by connecting Inclusive® Multi-Unit Abutment Analogs to the luted bar copings.

Glidewell HT™ Implant Multi-Unit Abutment

■ Try-in the Bar

- 1) Confirm that the multi-unit abutments seated on the endosseous implants are tightened to the recommended torque value (see “Torque Values” on page 8).
- 2) Seat the bar onto the multi-unit abutments. Hand-tighten an Inclusive® Multi-Unit Prosthetic Screw into either distal-most abutment.
- 3) Examine the other abutments to confirm no separation or lifting of the bar has resulted from tightening the first. Proceed to hand-tighten each abutment in turn, starting from the distal and moving forward, alternating between sides of the ridge.

IF A PASSIVE FIT IS ACHIEVED:

- 4) Remove the prosthetic screws and return the bar to the laboratory for fabrication of the final prosthesis.

IF A PASSIVE FIT IS NOT ACHIEVED:

- 4) Determine the two connection points between which the bar ceases to fit passively.
- 5) Remove the prosthetic screws and remove the bar from the patient’s mouth.
- 6) Using a high-speed disc bur, cut through the bar at the point where the bar ceases to fit passively.
- 7) Reseat the bar sections into the patient’s mouth and hand-tighten with prosthetic screws.
- 8) Apply autopolymerizing resin liberally to the separation point between the sections, and allow to set in the new configuration.
- 9) Remove and return the modified bar to the lab for fabrication.

■ Laboratory – Prepare the Final Prosthesis for Bar Retention

Follow procedures to process and finish the denture with the chosen bar attachments integrated.

■ Deliver the Final Restoration

- 1) Remove any temporary prosthesis.
- 2) Confirm that each multi-unit abutment is tightened to the recommended torque value (see “Torque Values” on page 8).
- 3) Line the prosthesis onto the abutments. Beginning with the midmost screw access channel, hand-tighten an Inclusive® Multi-Unit Prosthetic Screw into the multi-unit abutment. Repeat for each abutment, working outward and alternating left to right.
- 4) Confirm appropriate seating. With the same middle-out, left-to-right technique, tighten each prosthetic screw to 15 Ncm.
- 5) Check comfort and occlusion, and make any necessary adjustments.
- 6) Fill each screw access channel with gutta-percha, silicone, or other suitable temporary material.

LOCATOR® Abutment

Intended Use

The LOCATOR® Implant Attachment System is designed for use with overdentures or partial dentures, retained in whole or in part, by endosseous implants in the mandible or maxilla.

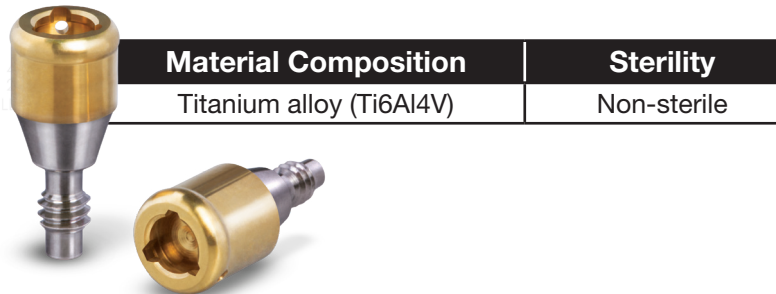

Contraindications

Not appropriate where a totally rigid connection is required. Use on a single implant with divergence of greater than 20 degrees is not recommended.

Caution

U.S. federal law restricts this device to sale by or on the order of a licensed dentist or physician.

Single-Use Devices

Locator Males: The inadvertent re-use of Locator nylon males could cause loss of retention for the overdenture due to wear from previous use or damage during removal with the Locator Core Tool.

Locator Abutments: The inadvertent re-use of Locator abutments could contain patient contamination build-up and subsequent wear of the retention bands. This would result in the device to perform with improper fit and function which would result in loss of retention for the prosthesis.

Sterilization

All components and instruments are supplied **NON-STERILE**.

Titanium abutments may be sterilized by Autoclave or Dry Heat sterilization using the following parameters:

1. Autoclave sterilize using 121°C (250°F), (15-20 psig at sea level), for twenty (20) minutes minimum.
2. Dry Heat sterilize using 170°C (338°F) for two (2) hours minimum.

Locator Core Tools (disassembled state only) may be sterilized by Autoclave or Dry Heat sterilization using the following parameters:

1. Autoclave sterilize using 121°C (250°F), 15-20 psig (at sea level), for forty (40) minutes minimum.
2. Dry Heat sterilize using 170°C (338°F) for two (2) hours minimum.

Locator Abutment Features

- **Lowest Vertical Height:** The total height of the Locator Attachment (abutment plus male) is only 3.17 mm on an externally hexed implant, and 2.5 mm on a non-hexed implant.

LOCATOR® Abutment

- **Locating Design:** Self-locating design allows a patient to easily seat their overdenture without the need for accurate alignment of the attachment components.
- **Retention Inside And Out:** The patented Dual Retention innovation provides the Locator Attachment with greater retention surface area than ever before available with other attachments. A combination of inside and outside retention ensures the longest lasting performance.
- **Rotational Pivoting Action:** The design of the pivoting Locator Male allows a resilient connection for the prosthesis without any resulting loss of retention. The retentive nylon male remains completely in contact with the abutment socket while its titanium denture cap has a full range of rotational movement over the male.
- **Use With Non-Parallel Implants:** The Locator Replacement Males can be used to restore an implant with up to 10 degrees of divergence (20 degrees between implants). The Locator Extended Range Replacement Males can accommodate a divergent implant between 10 and 20 degrees (40 degrees between implants).

Restorative Procedure with Locator Abutments

■ Place Locator Implant Abutment

- 1) To select the proper Locator Implant Abutment, determine the type of implant and the diameter being used. Then measure the tissue thickness from the apical rim of the implant body to the crest of the gingiva at the highest side of the implant site. Choose the corresponding abutment tissue cuff height that exactly equals the tissue measurement, or is the next closest higher size available. The exact tissue cuff height of Locator abutment will position the proper 1.5 mm of working attachment above the surrounding gingival level (which should not be submerged below the tissue).
- 2) After the secondary gingival healing period is complete, remove the healing cuff according to instructions provided by the manufacturer of the implant system being used.
- 3) It is imperative that all bone and soft tissue be removed from the superior aspect of the implant body to guarantee complete seating of the Locator Implant Abutment.
- 4) A special gold-plated Abutment Driver (#8390) contained in Locator Core Tool (#8393) is designed to engage the inside diameter of the Locator Abutment and thread it into the implant by hand. A Locator Abutment Retaining Sleeve (#8394) slips onto the Abutment Driver to hold the Locator Implant Abutment while delivering it to the implant site by hand.
- 5) Final torque tightening of the Locator Abutment to prevent screw loosening is achieved using the 30 Ncm Torque Wrench Kit (#9020). The 15 mm length Square Drive Torque Wrench Driver (#8926) is used when interocclusal space is limited, and the 21 mm length (#8927) is used when interference is caused by an adjacent tooth.

⚠ NOTE: Various connection types of Locator Torque Wrench Drivers are available that fit into commonly used implant torque wrenches to allow direct torque tightening of the Locator Implant Abutment. In addition, the use of any Torque Wrench with a .050" (1.25 mm) Hex Torque Wrench Driver Tip will fit into the backside of the Locator Abutment Driver. Use your own Torque Wrench with either of these options to achieve 30 Ncm that will help prevent screw loosening of the Locator Implant Abutment.

■ Measure Angle of Divergent Implants

- 1) Choose one of the four threads on the titanium Alignment Pin (#9531) which matches the type of implant being used.

LOCATOR® Abutment

- 2) Thread the Alignment Pin by hand directly into the divergent implant (or implant analog on a stone model), being careful not to cross-thread the pin. Place the stainless steel Angle Measurement Guide (#9530) behind the Alignment Pin, level with the path of prosthesis insertion, to determine the divergence in degrees. An additional Alignment Pin can be placed into an adjacent non-divergent implant to determine the difference in the angle between it and the divergent implant.

⚠ WARNING: If the alignment pin does not easily thread into an implant, do not force the insertion.

⚠ NOTE: An alternative method of determining the angulation of an implant is to first place the Locator abutment into the implant, and then snap a Locator Parallel Post (#8517) onto it. Use the Angle Measurement Guide (#9530) behind the Parallel Post to determine the angle of the implant.

- 3) Choose the final Locator nylon male retention liner based upon the determined angle measurement of each implant. If the divergence of an implant is less than 10 degrees, use one of the Locator Replacement Males (clear = 5 lbs., pink = 3 lbs., and blue = 1.5 lbs.). If the divergence of any implant is between 10 degrees and 20 degrees, then use one of the Extended Range Replacement Males (green = 4 lbs., orange = 2 lbs., and red = 1 lbs.) which can accommodate a divergent implant up to 20 degrees (40 degrees between implants).

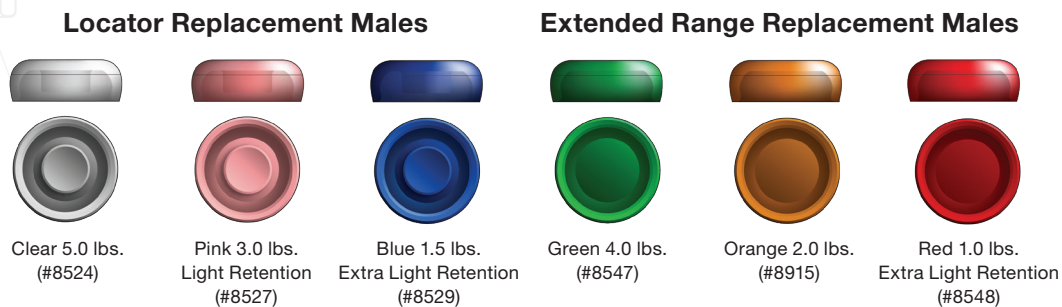

- 4) Follow the steps in the section entitled “Clinical Placement of the Locator Denture Cap Male” for chair-side placement of the Locator Male, or the steps in the section entitled “Laboratory Placement of the Locator Denture Cap Male” for indirect placement of the Locator Male.

■ Clinical Placement of the Locator Denture Cap Male

- 1) Insertion of the proper Locator Implant Abutment at tissue level must be completed (see “Place Locator Implant Abutment” on page 37) before beginning the procedure for placement of the Locator Denture Cap Processing Male Assembly.
- 2) Place a White Block-Out Spacer (contained in package #8519) over the head of each Locator Abutment. The spacer is used to block out the area immediately surrounding the abutment. The space created will allow the full resilient function of the pivoting metal denture cap over the Locator Black Processing Replacement Male.

⚠ NOTE: If the White Block-Out Spacer does not completely fill the space between the tissue and the metal denture cap, it is necessary to block out any remaining undercuts to prevent the added acrylic resin from locking the denture onto the abutment. This can be accomplished by stacking more Block-Out Spacers.

- 3) Insert a Locator Denture Cap Processing Male Assembly (contained in package #8519) onto each Locator Implant Abutment, leaving the White Block-Out Spacer beneath it. The Black Processing Replacement Male will maintain the overdenture in the upper limit of its vertical resiliency during the processing procedure.

LOCATOR® Abutment

- 4) Prepare a recess in the denture to accommodate the protruding Locator Denture Cap Processing Male Assembly. There must be no contact between the denture and the titanium cap. If the denture rests on the metal cap, excess pressure on the implant will result.
- 5) Use the Chairside Lightcure Acrylic Resin Syringe Kit (#9403) to light-cure bond the Locator Denture Cap Processing Male Assembly into the denture, or mix a permanent self-curing acrylic and place a small amount in the recess of the denture and around the metal cap of the Locator Denture Cap Processing Male Assembly.
- 6) Insert the denture into position in the oral cavity. Guide the patient into occlusion, maintaining a proper relationship with the opposing arch. Maintain the denture in a passive condition, without compression of the soft tissue, while the acrylic sets. Excessive occlusal pressure during the setting time may cause tissue recoil against the denture base and could contribute to dislodging and wear of the nylon males.
- 7) After the acrylic resin has cured, remove the denture and discard the White Block-Out Spacer. Use a bur to remove excess acrylic, and polish the denture base before changing to the final male.
- 8) Use the Locator Male Removal Tool (#8397) attached to the Locator Core Tool (#8393) to remove the Black Processing Replacement Male from the metal denture cap. The sharp circular edge on the end of the removal tool should be wedged tightly down into the very bottom of the Male so that it will catch the inside of the Male and pull it at an angle out of the metal housing. To discard the Male from the tip on the Core Tool, point the tool down and away from you and tighten the Male Removal Tool clockwise back onto the Core Tool. This will activate the removal pin and dislodge the Male from the tip end of the Male Removal Tool.
- 9) The Locator Male Seating Tool of the Locator Core Tool (#8393) is used to firmly push a Locator Replacement Male into the metal denture cap. The Replacement Male must seat securely into place, level with the rim of the cap.

⚠ NOTE: The Replacement Male will not stay on the tool when it is turned upside down due to the varying sizes of males available. It is best to hold the denture with the base side down and snap the male into the metal denture cap.

- 10) Instruct the patient in the path of insertion. Have the patient insert and remove the appliance several times.

■ Laboratory Placement of the Locator Denture Cap Male

IN THE OPERATORY:

- 1) Insertion of the proper Locator Implant Abutment at tissue level must be completed (see “Place Locator Implant Abutment” on page 37) before beginning the following impression procedure.
- 2) Place a Locator Impression Coping with Black Processing Replacement Male (#8505) onto each Locator Abutment.
- 3) Take an impression using a firm-body impression material, exercising caution not to compress the soft tissue. The Locator Impression Coping is designed with minimum retention to be picked up with the impression material.
- 4) Snap a Locator Female Analog (#8530 for 4 mm diameter) onto each Impression Coping in the impression. The Female Analog must not fall off when turned upside-down with vibration.

LOCATOR® Abutment

NOTE: An alternative reline impression technique using the patient's prosthesis is possible with use of the Locator Denture Cap Processing Male Assembly (contained in package #8519). When the impression is withdrawn, the Locator Denture Cap Processing Male Assembly will remain on the abutment. Remove the Locator Denture Cap Processing Male Assembly from each abutment and snap it onto a Locator Female Analog. Reposition this assembly back into the impression making sure it is fully seated.

IN THE LABORATORY:

- 5) Pour the master cast. Upon separation, the Locator Female Analog is a part of the master cast replicating the position of the Locator Implant Abutment in the oral cavity.
- 6) Before waxing and processing the appliance, place a Locator Denture Cap Processing Male Assembly onto each Female Analog in the master cast. Make sure the Denture Cap Processing Male Assembly is fully seated.
- 7) Set the teeth and wax the appliance. Proceed with the processing technique of your choice through the boil-out step.
- 8) After boil-out, remove the Locator Denture Cap Processing Male Assembly. Place a White Block-Out Spacer over the head of each Female Analog. The spacer is used to block out the immediate area surrounding the Locator Implant Abutment. The space created will allow the full resilient function of the pivoting metal denture cap over the Locator Nylon Male.
- 9) Reinsert the Locator Denture Cap Processing Male Assembly onto each Locator Female Analog, leaving the White Block-Out Spacer beneath it. The Black Processing Replacement Male will maintain the overdenture in the upper limit of its vertical resiliency during the processing procedure.

NOTE: If the dentist prefers to perform a chairside pick-up of the Locator Denture Cap Processing Male Assembly, use of the Locator Processing Spacer (#8569) will create the exact space needed.

- 10) Complete the processing and discard the White Block-Out Spacer. Polish the denture base before changing to the appropriate Locator Nylon Replacement Male.
- 11) Use the Locator Male Removal Tool (#8397) attached to the Locator Core Tool (#8393) to remove the Black Processing Replacement Male from the metal denture cap. The sharp circular edge on the end of the removal tool should be wedged tightly down into the very bottom of the Male so that it will catch the inside of the Male and pull it at an angle out of the metal housing. To discard the Male from the tip on the Core Tool, point the tool down and away from you and tighten the Male Removal Tool clockwise back onto the Core Tool. This will activate the removal pin and dislodge the Male from the tip end of the Male Removal Tool.
- 12) The Locator Male Seating Tool of the Locator Core Tool (#8393) is used to firmly push a Locator Replacement Male into the empty metal denture cap. The Replacement Male must seat securely into place, level with the rim of the cap.

NOTE: The Replacement Male will not stay on the tool when it is turned upside down due to the varying sizes of males available. It is best to hold the denture with the base side down and snap the male into the metal denture cap.

■ Change a Locator Male

- 1) The Locator Core Tool (#8393), which contains a Locator Male Removal Tool (#8397) and Locator Male Seating Tool, is used to remove the nylon male from the metal denture cap and replace it with another Locator Replacement Male.

LOCATOR® Abutment

- 2) Use the Locator Male Removal Tool attached to the Locator Core Tool to remove the nylon male from the metal denture cap. The sharp circular edge on the end of the removal tool should be wedged tightly down into the very bottom of the Male so that it will catch the inside of the Male and pull it at an angle out of the metal housing. To discard the nylon male from the tip on the Core Tool, point the tool down and away from you and tighten the Male Removal Tool clockwise back onto the Core Tool. This will activate the removal pin and dislodge the Male from the tip end of the Male Removal Tool.
- 3) The Male Seating Tool is used to firmly push a Locator Replacement Male into the empty metal denture cap. The Replacement Male must seat securely into place, level with the rim of the cap. Use of multiple Locator attachments (three or more) in the same dental arch may require use of the 1.5 pound (extra light retention) blue-colored Replacement Male (#8529), in combination with 0.0 pound (non-retentive) gray-colored Replacement Male (#8558) for easier removal of the prosthesis by the patient.

⚠ NOTE: The Replacement Male will not stay on the tool when it is turned upside down due to the varying sizes of males available. It is best to hold the denture with the base side down and snap the male into the metal denture cap.

■ Reline and Rebase

- 1) Remove each existing nylon male from its metal denture cap following the steps in “Change a Locator Male” on page 40. Replace them with Black Processing Replacement Males (#8515). The built-in spacer of the Black Processing Replacement Male will maintain the overdenture in its upper level of vertical resiliency during the reline process.
- 2) Take a reline impression using the existing overdenture as a tray. The Black Processing Replacement Males will engage the Locator Implant Abutments and hold the prosthesis in place while the impression material sets.
- 3) When the impression is withdrawn, the Black Processing Replacement Males will remain in the metal denture caps.
- 4) Snap a Locator Female Analog (#8530 for 4 mm diameter) onto each Locator Denture Cap Processing Male Assembly in the impression, and pour a master model.
- 5) After processing the reline and polishing the denture base, replace the Black Processing Replacement Males with the appropriate Locator Nylon Replacement Males.

■ Patient Care

Good oral hygiene is vital to attachment success. The Locator Implant Abutments must be thoroughly cleaned each day to prevent wear of the abutments due to buildup of abrasive plaque in the socket of the abutment. The use of a soft nylon bristle or end-tufted toothbrush, and superfloss to polish the abutments, should be taught. A non-abrasive gel toothpaste and an irrigation system is recommended to keep the socket of the Locator Abutment clean.

Patients should maintain a three-to-four-month recall for cleaning and attachment evaluation. The inside socket of the Locator Abutment and the sulcus area around the implant abutment are the primary areas of concern. Use plastic instruments for scaling the abutments. Do not use metal instruments, which may scratch the abutment surface. Examine patients for signs of inflammation around the implant abutments, and for implant mobility. Use a 30 Ncm torque wrench to make sure the Locator Implant Abutment is tight before dismissal.

Product Packaging

Glidewell HT™ Implant Prosthetic Components are delivered in boxed blister trays. They may be stored in a dry location at room temperature in this original packaging. Please refer to the individual product label for all relevant product information and cautions. Products labeled **STERILE** are intended for single-use only, prior to the expiration date. Do not use sterile products if the packaging has been compromised or previously opened. Do not re-sterilize. Products labeled **NON-STERILE** should be cleaned, disinfected, and sterilized according to a validated method prior to use in the oral environment.

Explanation of Label Codes:

1. Official product description
2. Date of Manufacture (YYYY-MM-DD)
3. Catalog Number
4. Lot/Batch Number
5. By Prescription Only
6. Do Not Use if Package is Damaged
7. Sterile with Gamma Radiation
8. Use-by Date
9. Consult Instructions for Use
10. Do not Re-use
11. Do not Resterilize
12. Manufacturer
13. Country of origin
14. Unique Device Identification (UDI)
15. Non-Sterile
16. QR code for IFU website

1 Glidewell HT™ Implant
Titanium Scan Body -
Ø3.0 Implant

3 **REF** 70-1190-PRA0054 1 pc.

4 **LOT** 1234567

14 **5** **Rx** only **15** **NON-STERILE** **10** Do not re-use

+D745701189PRA00540/\$\$71234567/16DYYYYYMMDDJ

9 <https://www.ifu.glidewell dental.com>
IFU CODE: IFU-012631
tel: (888) 402-1725

Scan QR code for link to URL
For more information email
mail@glidewell dental.com

12 Prismatic Dentalcraft, Inc.
2144 Michelson Drive
Irvine, CA 92612, USA
2 YYYY-MM-DD **13** Made in USA
LBL-012812_1

Ø3.0 x 11.5 mm

1 **Glidewell HT™ Implant**
Ø3.0 x 11.5 mm

7 **STERILE R** **8** Use by YYYY-MM-DD **11** **9** <https://ifu.glidewell dental.com>
IFU CODE: IFU-012631
tel: (888) 402-1725

6 Do not use if package is damaged. **10**

12 Prismatic Dentalcraft, Inc.
2144 Michelson Drive
Irvine, CA 92612, USA
2 YYYY-MM-DD **13** Made in USA **5** **Rx** only **14**

Scan QR code for link to URL
For more information email
mail@glidewell dental.com **16**

+D745701189IMP00010/\$\$3YYMMDD1234567/16DYYYYYMMDDR

Ø3.0 x 11.5 mm

Ø3.0 x 11.5 mm

4 **LOT** 1234567 1 pc.

3 **REF** 70-1189-IMP001 **Glidewell HT™** IMPLANT SYSTEM

Ø3.0 x 11.5 mm

Policies and Warranty

Product Return Policy

Products may be returned at the customer's expense for credit within 30 days of invoice date. All returned products must meet the following conditions:

- A copy of the original invoice must accompany the products.
- Products must be packaged to arrive at the seller's facility undamaged.
- Discontinued, obsolete, expired, damaged, or opened items will not be accepted for return.
- Amount credited will be based on invoice price, less 15 percent for restocking fee.
- Shipping charges are the responsibility of the customer and will not be credited.

Product & Pricing Changes

Because products and equipment are continually undergoing refinement in design and manufacturing methods, we reserve the right to improve, modify, or discontinue products and equipment or change pricing at any time without incurring any obligation and without prior notice.

Warranty

Limited Warranty—Prismatik Dentalcraft, Inc.

Prismatik Dentalcraft, Inc. ("Prismatik"), is the manufacturer of dental products (the "product"), including Glidewell HT™ Implants ("implants"). Prismatik warrants the Glidewell HT Implant for the life of the patient originally receiving the implant from the date of placement, and for a period of six (6) months for ceramic blanks and any other product ("the warranty period"). Prismatik will at its option replace or refund the purchase price of any product, to the original purchaser ("user"), that is returned due to defects in material and manufacture.

NO GUARANTEE OR WARRANTY IS IMPLIED OTHER THAN EXPRESSLY STATED, INCLUDING ANY IMPLIED WARRANTY OF MERCHANTABILITY OR FITNESS FOR A PARTICULAR PURPOSE.

Prismatik shall not be liable for any incidental or consequential damages, whether foreseeable or not, caused by defects in the product or dental devices produced using said product. User is responsible for determining the suitability of the product for user's application. If this product is defective within the warranty period, user's exclusive remedy and Prismatik's sole obligation shall be replacement or refund of the purchase price of the product. For replacement or refund under this warranty, the original purchaser shall send the product at its own expense, postage prepaid, to the seller.

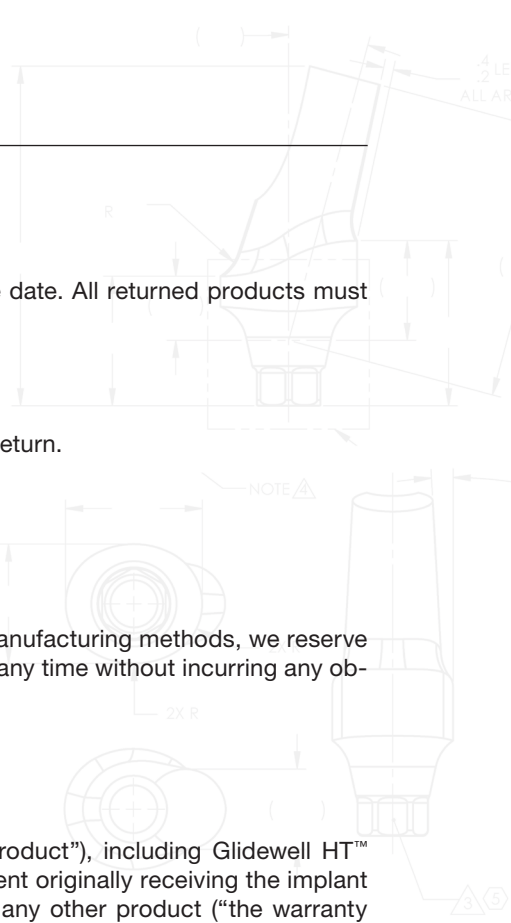

Glidewell HT™

IMPLANT SYSTEM

Formerly the Hahn™ Tapered Implant System



Official implant of the



Designed & Manufactured in the U.S.A.

by



2144 Michelson Drive • Irvine, CA 92612, USA

To Order Call:

888-303-3975

Online:

glidewell-ht.com